

# INDUSTRIAL ALUMINIUM PROFILE SYSTEMS

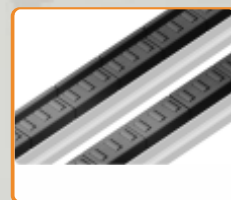

MODULAR CONSTRUCTION TECHNOLOGIES  
ACCESSORIES CONVEYORS SYSTEMS

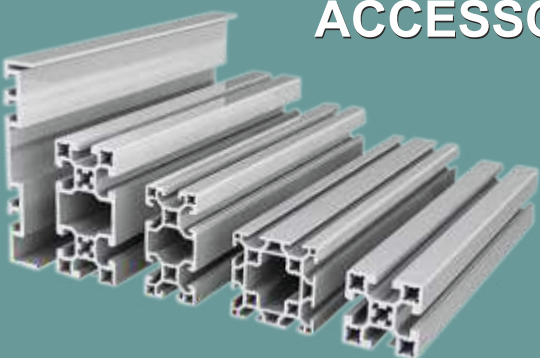

TIMOKATAΛOΓΟΣ  
PRICE LIST  
2025  
JANUARY

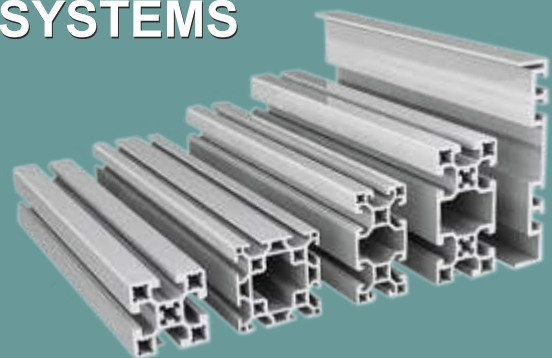

e-mail: [sales@aluminium-profile.gr](mailto:sales@aluminium-profile.gr)

[www.aluminium-profile.gr](http://www.aluminium-profile.gr)

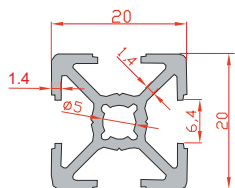
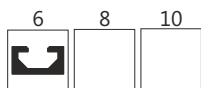

TIMH/m  
KOMMATI  
**6,00 €**

Code	Product Name	Material	Moment of Inertia		Moment of Resistance		Area	Weight
			$I_x$	$I_y$	$W_x$	$W_y$		
<b>M 63</b>	20x20	6063	0,61cm <sup>4</sup>	0,61cm <sup>4</sup>	0,61cm <sup>3</sup>	0,61cm <sup>3</sup>	1,42cm <sup>2</sup>	0,38 Kg/m

TIMH/m  
\*6m ΒΕΡΓΑΣ  
**5,40 €**

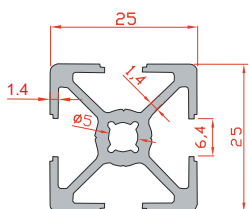

TIMH/m  
KOMMATI  
**8,00 €**

Code	Product Name	Material	Moment of Inertia		Moment of Resistance		Area	Weight
			$I_x$	$I_y$	$W_x$	$W_y$		
<b>M 63/A</b>	25x25	6063	1,39cm <sup>4</sup>	1,39cm <sup>4</sup>	1,11cm <sup>3</sup>	1,11cm <sup>3</sup>	2,12cm <sup>2</sup>	0,55 Kg/m

TIMH/m  
\*6m ΒΕΡΓΑΣ  
**7,20 €**

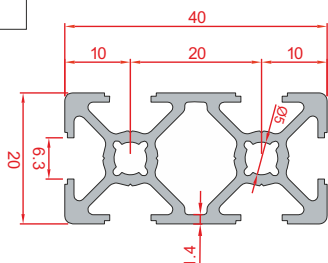
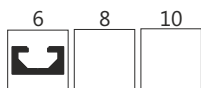

TIMH/m  
KOMMATI  
**11,00 €**

Code	Product Name	Material	Moment of Inertia		Moment of Resistance		Area	Weight
			$I_x$	$I_y$	$W_x$	$W_y$		
<b>M 99</b>	20x40	6063	4,17cm <sup>4</sup>	1,12cm <sup>4</sup>	2,08cm <sup>3</sup>	1,12cm <sup>3</sup>	2,6cm <sup>2</sup>	0,73 Kg/m

TIMH/m  
\*6m ΒΕΡΓΑΣ  
**9,90 €**

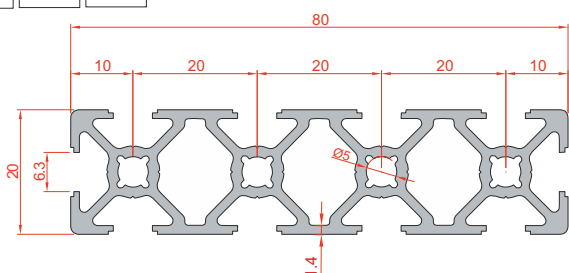

TIMH/m  
KOMMATI  
**21,50 €**

Code	Product Name	Material	Moment of Inertia		Moment of Resistance		Area	Weight
			$I_x$	$I_y$	$W_x$	$W_y$		
<b>M 95</b>	20x80	6063	29,14cm <sup>4</sup>	2,12cm <sup>4</sup>	7,28cm <sup>3</sup>	2,12cm <sup>3</sup>	4,88cm <sup>2</sup>	1,32 Kg/m

TIMH/m  
\*6m ΒΕΡΓΑΣ  
**19,35 €**

\*ΕΛΑΧΙΣΤΟ ΜΗΚΟΣ ΚΟΠΗΣ 1200 χιλ. (ΓΙΑ 6ΜΕΤΡΕΣ ΒΕΡΓΕΣ)

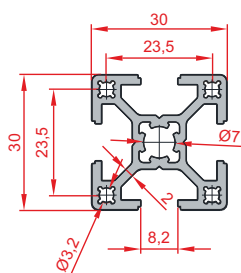

**ΜΑΥΡΟ ΑΝΟΔΙΩΜΕΝΟ ΚΑΤΟΠΙΝ ΠΑΡΑΓΓΕΛΙΑΣ**



TIMH/m  
KOMMATI  
**12,40 €**

TIMH/m  
\*6m ΒΕΡΓΑΣ  
**11,15 €**

Code	Product Name	Material	Moment of Inertia		Moment of Resistance		Area	Weight
			$I_x$	$I_y$	$W_x$	$W_y$		
<b>M 22</b>	30X30	6063	2,95cm <sup>4</sup>	2,95cm <sup>4</sup>	1,97cm <sup>3</sup>	1,97cm <sup>3</sup>	3,16cm <sup>2</sup>	0,85 Kg/m

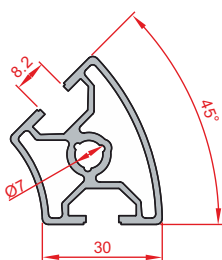

TIMH/m  
KOMMATI  
**15,20 €**

TIMH/m  
\*6m ΒΕΡΓΑΣ  
**13,65 €**

Code	Product Name	Material	Moment of Inertia		Moment of Resistance		Area	Weight
			$I_x$	$I_y$	$W_x$	$W_y$		
<b>M 30X45 D</b>	30x45	6063	3,02cm <sup>4</sup>	4,57cm <sup>4</sup>	2,1cm <sup>3</sup>	2,2cm <sup>3</sup>	3,35cm <sup>2</sup>	0,91 Kg/m

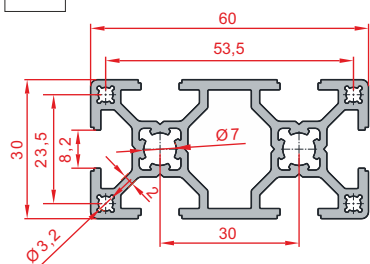

TIMH/m  
KOMMATI  
**20,90 €**

TIMH/m  
\*6m ΒΕΡΓΑΣ  
**18,85 €**

Code	Product Name	Material	Moment of Inertia		Moment of Resistance		Area	Weight
			$I_x$	$I_y$	$W_x$	$W_y$		
<b>M 26</b>	30X60	6063	20,12cm <sup>4</sup>	5,46cm <sup>4</sup>	6,71cm <sup>3</sup>	3,64cm <sup>3</sup>	5,59cm <sup>2</sup>	1,51 Kg/m

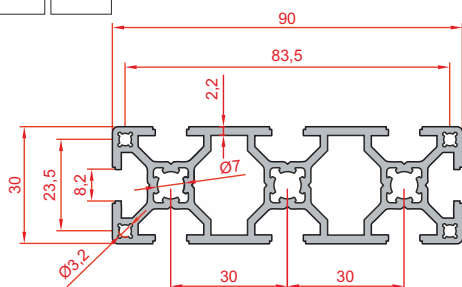

TIMH/m  
KOMMATI  
**33,00 €**

TIMH/m  
\*6m ΒΕΡΓΑΣ  
**29,70 €**

Code	Product Name	Material	Moment of Inertia		Moment of Resistance		Area	Weight
			$I_x$	$I_y$	$W_x$	$W_y$		
<b>M 19</b>	30X90	6063	63,29cm <sup>4</sup>	7,99cm <sup>4</sup>	14,06cm <sup>3</sup>	5,32cm <sup>3</sup>	8,12cm <sup>2</sup>	2,19 Kg/m

\*ΕΛΑΧΙΣΤΟ ΜΗΚΟΣ ΚΟΠΗΣ 1200 χιλ. (ΓΙΑ 6ΜΕΤΡΕΣ ΒΕΡΓΕΣ)



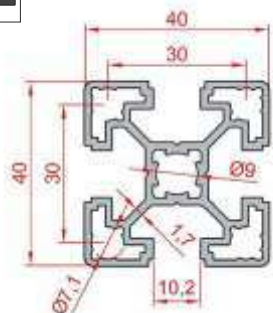

**ΜΑΥΡΟ ΑΝΟΔΙΩΜΕΝΟ ΚΑΤΟΠΙΝ ΠΑΡΑΓΓΕΛΙΑΣ**



TIMH/m KOMMATI

17,30 €

TIMH/m \*6m ΒΕΡΓΑΣ

15,55 €

Code	Product Name	Material	Moment of Inertia		Moment of Resistance		Area	Weight
			$I_x$	$I_y$	$W_x$	$W_y$		
<b>M 04</b>	40x40	6063	7,10cm <sup>4</sup>	7,10cm <sup>4</sup>	3,55cm <sup>3</sup>	3,55cm <sup>3</sup>	4,49cm <sup>2</sup>	1,21Kg/m

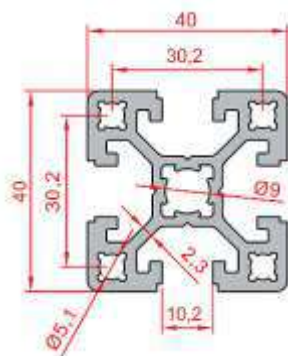

TIMH/m KOMMATI

23,00 €

TIMH/m \*6m ΒΕΡΓΑΣ

20,70 €

Code	Product Name	Material	Moment of Inertia		Moment of Resistance		Area	Weight
			$I_x$	$I_y$	$W_x$	$W_y$		
<b>M 04/A</b>	40x40 Heavy (S10)	6063	10,37cm <sup>4</sup>	10,37cm <sup>4</sup>	6,05cm <sup>3</sup>	6,05cm <sup>3</sup>	6,12cm <sup>2</sup>	1,65 Kg/m

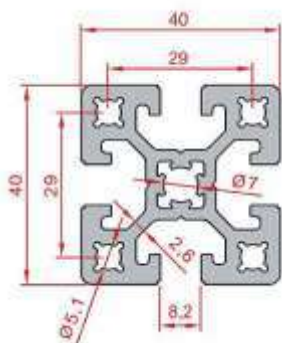

TIMH/m KOMMATI

27,90 €

TIMH/m \*6m ΒΕΡΓΑΣ

25,10 €

Code	Product Name	Material	Moment of Inertia		Moment of Resistance		Area	Weight
			$I_x$	$I_y$	$W_x$	$W_y$		
<b>M 04/G</b>	40x40 Heavy (S8)	6063	12,1cm <sup>4</sup>	12,1cm <sup>4</sup>	5,18cm <sup>3</sup>	5,18cm <sup>3</sup>	7,32cm <sup>2</sup>	1,98 Kg/m

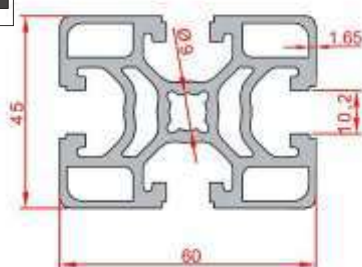

TIMH/m KOMMATI

39,30 €

TIMH/m \*6m ΒΕΡΓΑΣ

35,40 €

Code	Product Name	Material	Moment of Inertia		Moment of Resistance		Area	Weight
			$I_x$	$I_y$	$W_x$	$W_y$		
<b>M 13</b>	45x60	6063	31,29 cm <sup>4</sup>	18,45 cm <sup>4</sup>	10,4cm <sup>3</sup>	8,2cm <sup>3</sup>	9,45 cm <sup>2</sup>	2,61 Kg/m

\*ΕΛΑΧΙΣΤΟ ΜΗΚΟΣ ΚΟΠΗΣ 1200 χιλ. (ΓΙΑ 6ΜΕΤΡΕΣ ΒΕΡΓΕΣ)

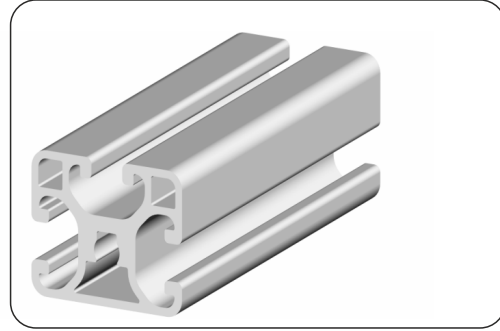
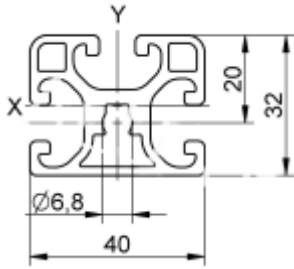
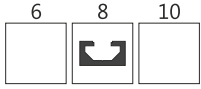

TIMH/m  
KOMMATI  
**26,00 €**

Code	Product Name	Material	Moment of Inertia		Moment of Resistance		Area	Weight
			$I_x$	$I_y$	$W_x$	$W_y$		
<b>MF 432</b>	40x32	6063	5,00 cm <sup>4</sup>	7,03 cm <sup>4</sup>	3,10 cm <sup>3</sup>	3,52 cm <sup>3</sup>	4,90 cm <sup>2</sup>	1,32 Kg/m

TIMH/m  
\*6m ΒΕΡΓΑΣ  
**23,40 €**

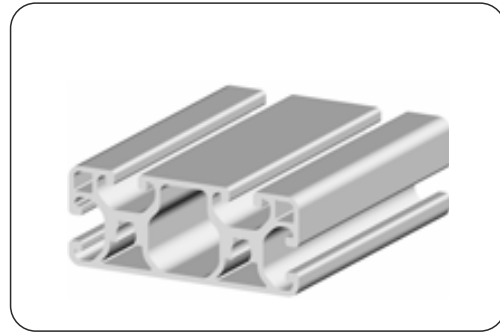
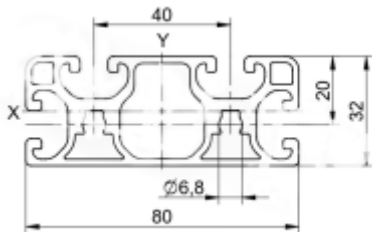

TIMH/m  
KOMMATI  
**43,00 €**

Code	Product Name	Material	Moment of Inertia		Moment of Resistance		Area	Weight
			$I_x$	$I_y$	$W_x$	$W_y$		
<b>MF 328</b>	80x32	6063	9,44 cm <sup>4</sup>	53,14 cm <sup>4</sup>	5,90 cm <sup>3</sup>	13,29 cm <sup>3</sup>	8,63 cm <sup>2</sup>	2,33 Kg/m

TIMH/m  
\*6m ΒΕΡΓΑΣ  
**38,70 €**

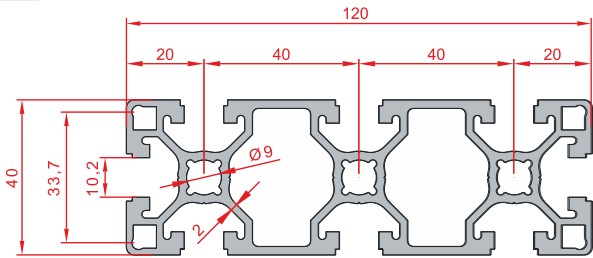
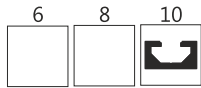

TIMH/m  
KOMMATI  
**58,00 €**

Code	Product Name	Material	Moment of Inertia		Moment of Resistance		Area	Weight
			$I_x$	$I_y$	$W_x$	$W_y$		
<b>M 21</b>	40x120	6063	200,5 cm <sup>4</sup>	25,7 cm <sup>4</sup>	33,1 cm <sup>3</sup>	13,2 cm <sup>3</sup>	13,93 cm <sup>2</sup>	3,76 Kg/m

TIMH/m  
\*6m ΒΕΡΓΑΣ  
**52,20 €**

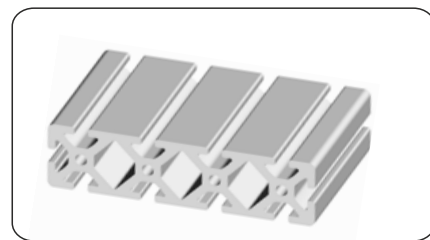
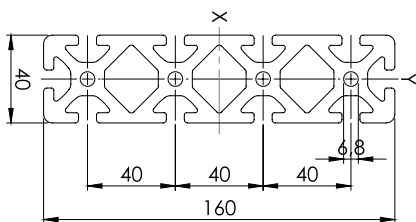

TIMH/m  
KOMMATI  
**155,00 €**

Code	Product Name	Material	Moment of Inertia		Moment of Resistance		Area	Weight
			$I_x$	$I_y$	$W_x$	$W_y$		
<b>MF 416H</b>	40x160 Heavy	6063	738,38 cm <sup>4</sup>	53,34 cm <sup>4</sup>	92,30 cm <sup>3</sup>	26,67 cm <sup>3</sup>	31,93 cm <sup>2</sup>	8,62 Kg/m

TIMH/m  
\*6m ΒΕΡΓΑΣ  
**139,50 €**

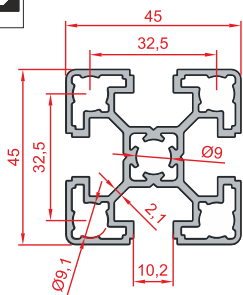
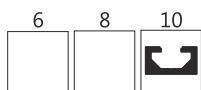

**ΜΑΥΡΟ ΑΝΟΔΙΩΜΕΝΟ ΚΑΤΟΠΙΝ ΠΑΡΑΓΓΕΛΙΑΣ**



TIMH/m  
KOMMATI  
**21,40 €**

TIMH/m  
\*6m ΒΕΡΓΑΣ  
**19,25 €**

Code	Product Name	Material	Moment of Inertia		Moment of Resistance		Area	Weight
			$I_x$	$I_y$	$W_x$	$W_y$		
<b>M 12</b>	45x45	6063	11,09 cm <sup>4</sup>	11,09 cm <sup>4</sup>	4,93cm <sup>3</sup>	4,93cm <sup>3</sup>	5,62cm <sup>2</sup>	1,52 Kg/m

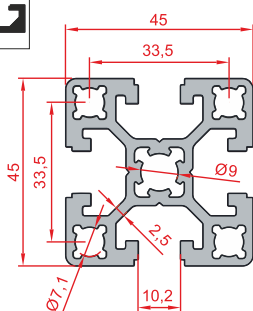

TIMH/m  
KOMMATI  
**29,00 €**

TIMH/m  
\*6m ΒΕΡΓΑΣ  
**26,10 €**

Code	Product Name	Material	Moment of Inertia		Moment of Resistance		Area	Weight
			$I_x$	$I_y$	$W_x$	$W_y$		
<b>M 12/E</b>	45x45 Heavy	6063	15,65 cm <sup>4</sup>	15,65 cm <sup>4</sup>	6,9cm <sup>3</sup>	6,9cm <sup>3</sup>	7,63cm <sup>2</sup>	2,06 Kg/m

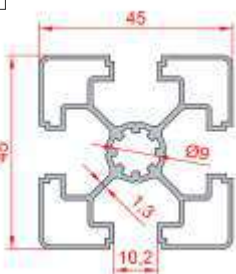
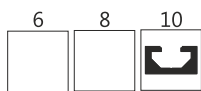

TIMH/m  
KOMMATI  
**15,50 €**

TIMH/m  
\*6m ΒΕΡΓΑΣ  
**13,95 €**

Code	Product Name	Material	Moment of Inertia		Moment of Resistance		Area	Weight
			$I_x$	$I_y$	$W_x$	$W_y$		
<b>M 12/L</b>	45x45 Light	6063	6,64 cm <sup>4</sup>	6,64 cm <sup>4</sup>	2,95 cm <sup>3</sup>	2,95 cm <sup>3</sup>	3,54 cm <sup>2</sup>	0,96 Kg/m

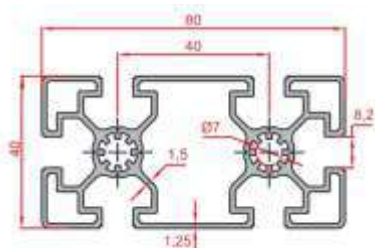

TIMH/m  
KOMMATI  
**33,80 €**

TIMH/m  
\*6m ΒΕΡΓΑΣ  
**30,40 €**

Code	Product Name	Material	Moment of Inertia		Moment of Resistance		Area	Weight
			$I_x$	$I_y$	$W_x$	$W_y$		
<b>M 03/Z</b>	40x80 Light S8	6063	11,54 cm <sup>4</sup>	46,89 cm <sup>4</sup>	5,77 cm <sup>3</sup>	11,72 cm <sup>3</sup>	7,07 cm <sup>2</sup>	1,92 Kg/m

\*ΕΛΑΧΙΣΤΟ ΜΗΚΟΣ ΚΟΠΗΣ 1200 χιλ. (ΓΙΑ 6ΜΕΤΡΕΣ ΒΕΡΓΕΣ)

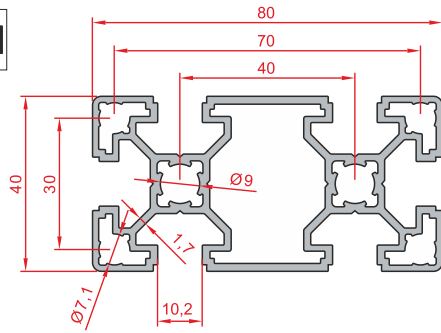
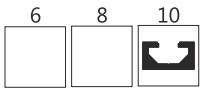

TIMH/m  
KOMMATI

28,90 €

TIMH/m  
\*6m ΒΕΡΓΑΣ

26,00 €

Code	Product Name	Material	Moment of Inertia		Moment of Resistance		Area	Weight
			$I_x$	$I_y$	$W_x$	$W_y$		
<b>M 03</b>	40x80	6063	49,98 cm <sup>4</sup>	13,13 cm <sup>4</sup>	12,49cm <sup>3</sup>	6,56cm <sup>3</sup>	7,67 cm <sup>2</sup>	2,08 Kg/m

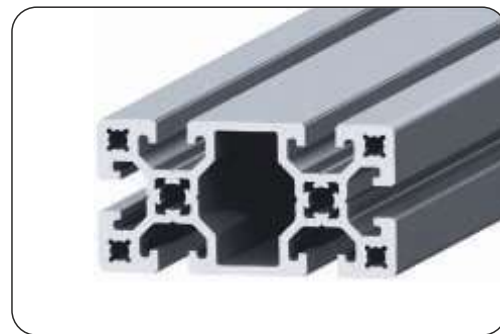
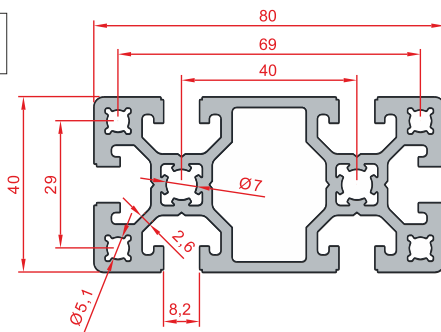

TIMH/m  
KOMMATI

46,80 €

TIMH/m  
\*6m ΒΕΡΓΑΣ

42,15 €

Code	Product Name	Material	Moment of Inertia		Moment of Resistance		Area	Weight
			$I_x$	$I_y$	$W_x$	$W_y$		
<b>M 03/B</b>	40x80 Heavy (S8)	6063	82,3 cm <sup>4</sup>	20,9 cm <sup>4</sup>	17,38cm <sup>3</sup>	9,25cm <sup>3</sup>	11,9 cm <sup>2</sup>	3,23 Kg/m

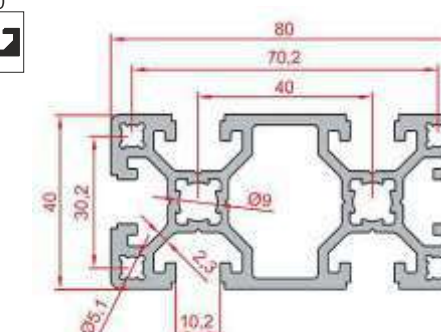

TIMH/m  
KOMMATI

41,80 €

TIMH/m  
\*6m ΒΕΡΓΑΣ

37,60 €

Code	Product Name	Material	Moment of Inertia		Moment of Resistance		Area	Weight
			$I_x$	$I_y$	$W_x$	$W_y$		
<b>M 03/A</b>	40x80 Heavy (S10)	6063	69,52 cm <sup>4</sup>	18,51 cm <sup>4</sup>	17,38 cm <sup>3</sup>	9,25 cm <sup>3</sup>	10,23 cm <sup>2</sup>	2,77 Kg/m

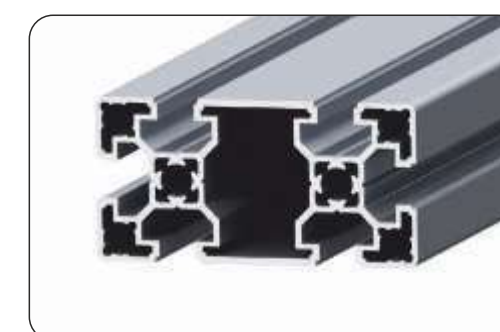
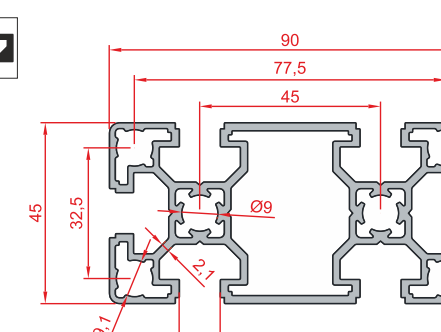

TIMH/m  
KOMMATI

36,00 €

TIMH/m  
\*6m ΒΕΡΓΑΣ

32,40 €

Code	Product Name	Material	Moment of Inertia		Moment of Resistance		Area	Weight
			$I_x$	$I_y$	$W_x$	$W_y$		
<b>M 10</b>	45x90	6063	78,98 cm <sup>4</sup>	20,74 cm <sup>4</sup>	17,5cm <sup>3</sup>	9,2cm <sup>3</sup>	9,63 cm <sup>2</sup>	2,61 Kg/m

\*ΕΛΑΧΙΣΤΟ ΜΗΚΟΣ ΚΟΠΗΣ 1200 χιλ. (ΓΙΑ 6ΜΕΤΡΕΣ ΒΕΡΓΕΣ)



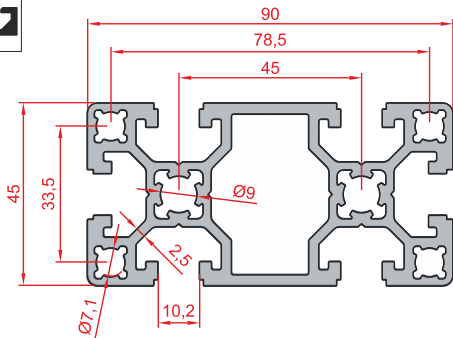
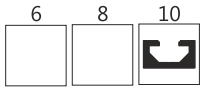

TIMH/m  
KOMMATI  
**49,20 €**

TIMH/m  
\*6m ΒΕΡΓΑΣ  
**44,30 €**

Code	Product Name	Material	Moment of Inertia		Moment of Resistance		Area	Weight
			$I_x$	$I_y$	$W_x$	$W_y$		
<b>M 10/B</b>	45x90 Heavy	6063	108,14 cm <sup>4</sup>	28,67 cm <sup>4</sup>	24,03cm <sup>3</sup>	12,74cm <sup>3</sup>	12,86 cm <sup>2</sup>	3,48 Kg/m

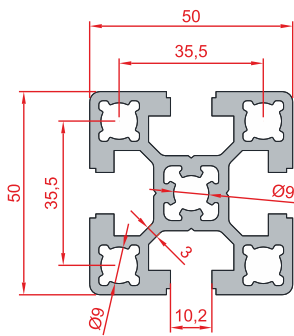
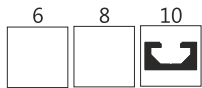

TIMH/m  
KOMMATI  
**39,90 €**

TIMH/m  
\*6m ΒΕΡΓΑΣ  
**35,90 €**

Code	Product Name	Material	Moment of Inertia		Moment of Resistance		Area	Weight
			$I_x$	$I_y$	$W_x$	$W_y$		
<b>M 46</b>	50x50	6063	24,7 cm <sup>4</sup>	24,5 cm <sup>4</sup>	9,88 cm <sup>3</sup>	9,88 cm <sup>3</sup>	10 cm <sup>2</sup>	2,71 Kg/m

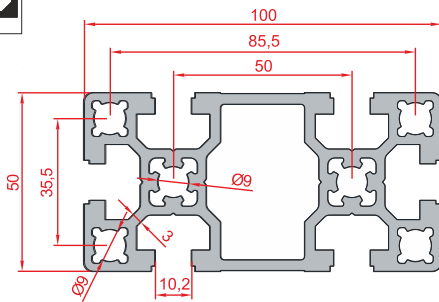

TIMH/m  
KOMMATI  
**72,00 €**

TIMH/m  
\*6m ΒΕΡΓΑΣ  
**64,80 €**

Code	Product Name	Material	Moment of Inertia		Moment of Resistance		Area	Weight
			$I_x$	$I_y$	$W_x$	$W_y$		
<b>M 101</b>	50x100	6063	175 cm <sup>4</sup>	45,2 cm <sup>4</sup>	35cm <sup>3</sup>	18,1cm <sup>3</sup>	16,92cm <sup>2</sup>	4,55 Kg/m

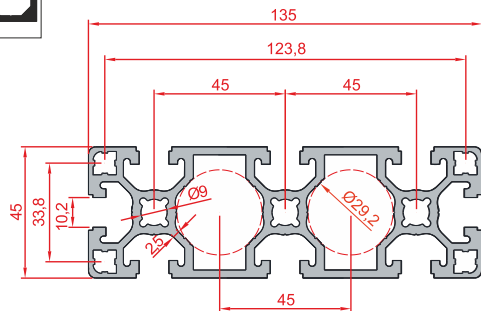
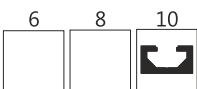

TIMH/m  
KOMMATI  
**75,00 €**

TIMH/m  
\*6m ΒΕΡΓΑΣ  
**67,50 €**

Code	Product Name	Material	Moment of Inertia		Moment of Resistance		Area	Weight
			$I_x$	$I_y$	$W_x$	$W_y$		
<b>M 60</b>	45x135	6063	41,8cm <sup>4</sup>	32,4cm <sup>4</sup>	6,19cm <sup>3</sup>	14,4cm <sup>3</sup>	18,3cm <sup>2</sup>	5 Kg/m

\*ΕΛΑΧΙΣΤΟ ΜΗΚΟΣ ΚΟΠΗΣ 1200 χιλ. (ΓΙΑ 6ΜΕΤΡΕΣ ΒΕΡΓΑΣ)

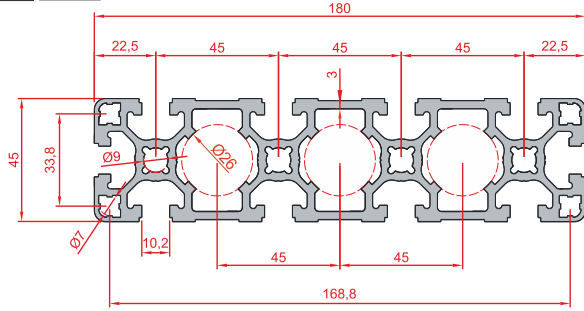
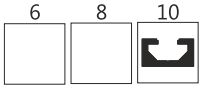

TIMH/m  
KOMMATI  
**105,00 €**

TIMH/m  
\*6m ΒΕΡΓΑΣ  
**94,50 €**

Code	Product Name	Material	Moment of Inertia		Moment of Resistance		Area	Weight
			$I_x$	$I_y$	$W_x$	$W_y$		
<b>M 15</b>	45x180	6063	747cm <sup>4</sup>	56,7cm <sup>4</sup>	83cm <sup>3</sup>	25,2cm <sup>3</sup>	25,1cm <sup>2</sup>	6,84 Kg/m

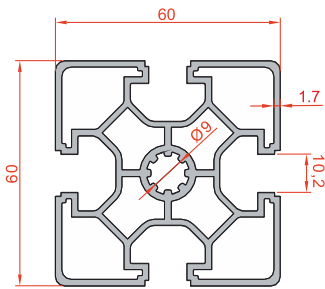
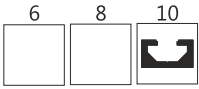

TIMH/m  
KOMMATI  
**35,50 €**

TIMH/m  
\*6m ΒΕΡΓΑΣ  
**31,95 €**

Code	Product Name	Material	Moment of Inertia		Moment of Resistance		Area	Weight
			$I_x$	$I_y$	$W_x$	$W_y$		
<b>M 28</b>	60x60	6063	29,85 cm <sup>4</sup>	29,85 cm <sup>4</sup>	9,9cm <sup>3</sup>	9,9cm <sup>3</sup>	8,8cm <sup>2</sup>	2,36 Kg/m

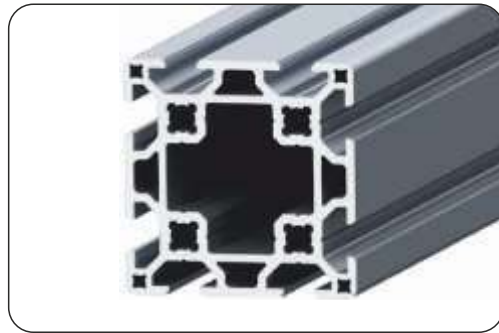
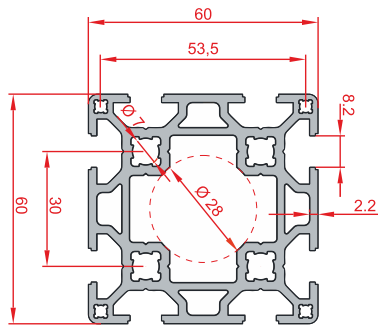

TIMH/m  
KOMMATI  
**43,20 €**

TIMH/m  
\*6m ΒΕΡΓΑΣ  
**38,90 €**

Code	Product Name	Material	Moment of Inertia		Moment of Resistance		Area	Weight
			$I_x$	$I_y$	$W_x$	$W_y$		
<b>M 28/B</b>	60x60 Heavy	6063	41 cm <sup>4</sup>	41 cm <sup>4</sup>	13,6cm <sup>3</sup>	13,6cm <sup>3</sup>	11,06cm <sup>2</sup>	3,06 Kg/m

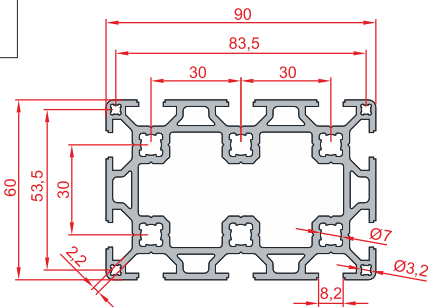

TIMH/m  
KOMMATI  
**67,00 €**

TIMH/m  
\*6m ΒΕΡΓΑΣ  
**60,30 €**

Code	Product Name	Material	Moment of Inertia		Moment of Resistance		Area	Weight
			$I_x$	$I_y$	$W_x$	$W_y$		
<b>M 28/X</b>	60x90	6063	59,4cm <sup>4</sup>	122cm <sup>4</sup>	26,8cm <sup>3</sup>	46,51cm <sup>3</sup>	14,7cm <sup>2</sup>	4,34 Kg/m

\*ΕΛΑΧΙΣΤΟ ΜΗΚΟΣ ΚΟΠΗΣ 1200 χιλ. (ΓΙΑ 6ΜΕΤΡΕΣ ΒΕΡΓΕΣ)

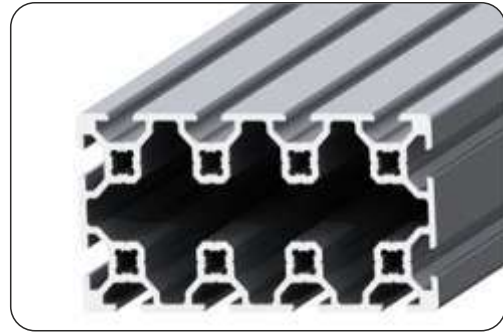
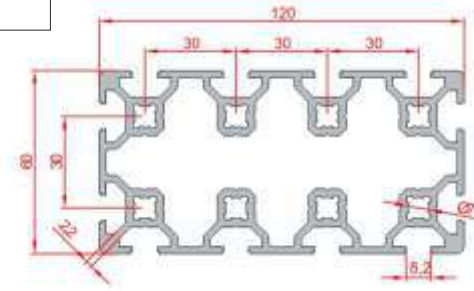
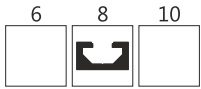

TIMH/m  
KOMMATI  
**75,00 €**

TIMH/m  
\*6m ΒΕΡΓΑΣ  
**67,50 €**

Code	Product Name	Material	Moment of Inertia		Moment of Resistance		Area	Weight
			$I_x$	$I_y$	$W_x$	$W_y$		
<b>M 28/Y</b>	60x120	6063	75,68cm <sup>4</sup>	265,05cm <sup>4</sup>	25,22cm <sup>3</sup>	44,17cm <sup>3</sup>	17,48cm <sup>2</sup>	4,74 Kg/m

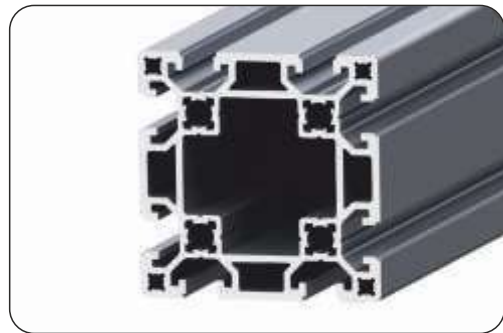
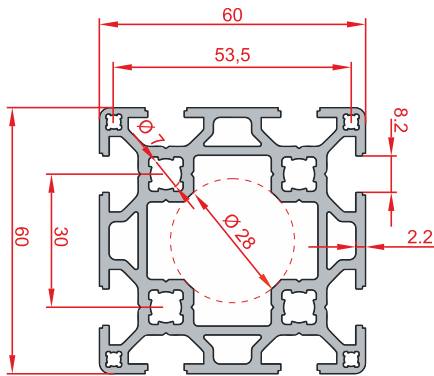

TIMH/m  
KOMMATI  
**83,00 €**

TIMH/m  
\*6m ΒΕΡΓΑΣ  
**74,70 €**

Code	Product Name	Material	Moment of Inertia		Moment of Resistance		Area	Weight
			$I_x$	$I_y$	$W_x$	$W_y$		
<b>M 02/B</b>	80x80 Heavy (S8)	6063	41 cm <sup>4</sup>	41 cm <sup>4</sup>	13,6 cm <sup>3</sup>	13,6 cm <sup>3</sup>	11,06 cm <sup>2</sup>	5,39 Kg/m

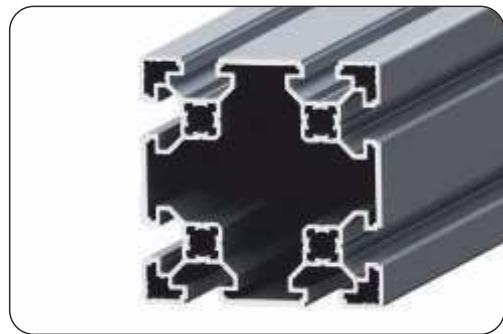
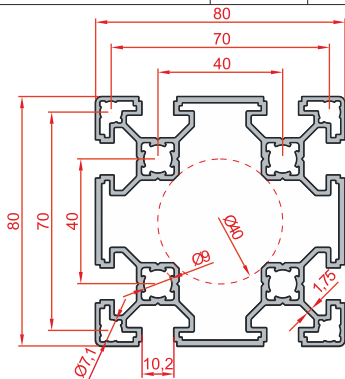
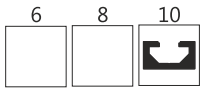

TIMH/m  
KOMMATI  
**46,00 €**

TIMH/m  
\*6m ΒΕΡΓΑΣ  
**41,40 €**

Code	Product Name	Material	Moment of Inertia		Moment of Resistance		Area	Weight
			$I_x$	$I_y$	$W_x$	$W_y$		
<b>M 02</b>	80x80	6063	88,08cm <sup>4</sup>	88,08cm <sup>4</sup>	22,02cm <sup>3</sup>	22,02cm <sup>3</sup>	11,91cm <sup>2</sup>	3,23 Kg/m

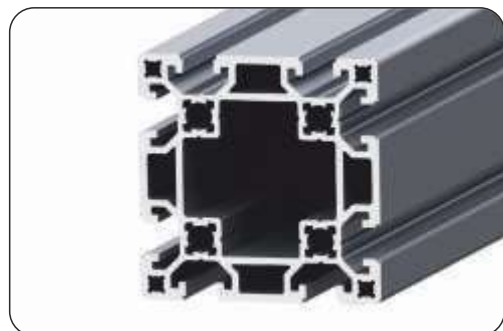
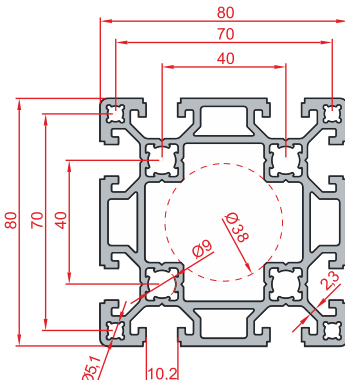

TIMH/m  
KOMMATI  
**70,00 €**

TIMH/m  
\*6m ΒΕΡΓΑΣ  
**63,00 €**

Code	Product Name	Material	Moment of Inertia		Moment of Resistance		Area	Weight
			$I_x$	$I_y$	$W_x$	$W_y$		
<b>M 02/A</b>	80x80 Heavy (S10)	6063	127,1cm <sup>4</sup>	127,1cm <sup>4</sup>	31,78cm <sup>3</sup>	31,78cm <sup>3</sup>	17,77cm <sup>2</sup>	4,81 Kg/m

\*ΕΛΑΧΙΣΤΟ ΜΗΚΟΣ ΚΟΠΗΣ 1200 χιλ. (ΓΙΑ 6ΜΕΤΡΕΣ ΒΕΡΓΕΣ)

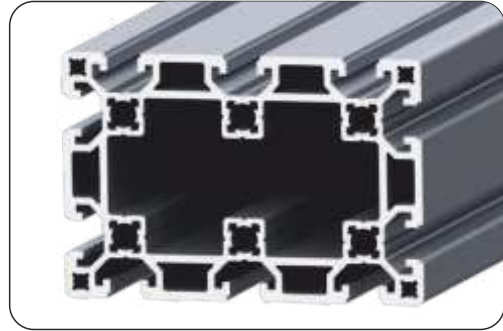
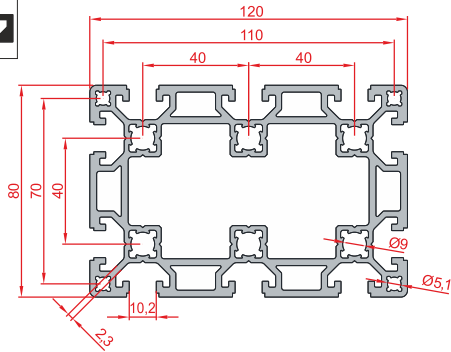
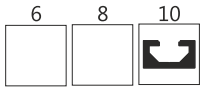

TIMH/m  
KOMMATI  
**103,00 €**

TIMH/m  
\*6m ΒΕΡΓΑΣ  
**92,70 €**

Code	Product Name	Material	Moment of Inertia		Moment of Resistance		Area	Weight
			I <sub>x</sub>	I <sub>y</sub>	W <sub>x</sub>	W <sub>y</sub>		
<b>M 02/X</b>	80x120	6063	185,3cm <sup>4</sup>	379,5cm <sup>4</sup>	60,55cm <sup>3</sup>	210,95cm <sup>3</sup>	24,3cm <sup>2</sup>	6,59 Kg/m

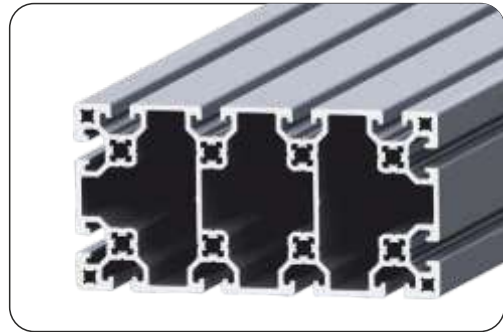
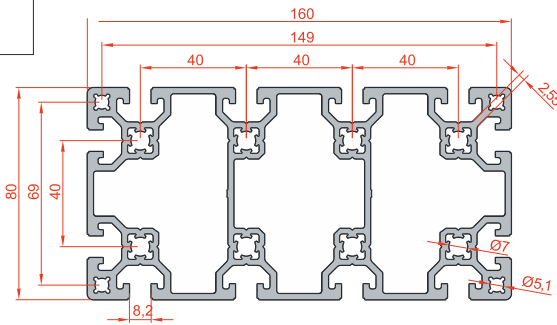

TIMH/m  
KOMMATI  
**129,00 €**

TIMH/m  
\*6m ΒΕΡΓΑΣ  
**116,10 €**

Code	Product Name	Material	Moment of Inertia		Moment of Resistance		Area	Weight
			I <sub>x</sub>	I <sub>y</sub>	W <sub>x</sub>	W <sub>y</sub>		
<b>MG 160</b>	80x160	6063	242,2cm <sup>4</sup>	843,8cm <sup>4</sup>	60,55cm <sup>3</sup>	210,95cm <sup>3</sup>	30,5cm <sup>2</sup>	8,28 Kg/m

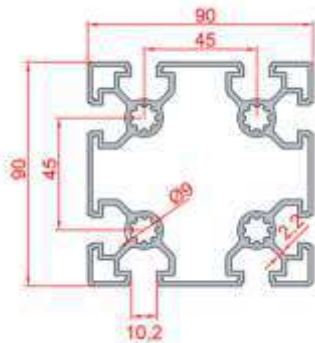

TIMH/m  
KOMMATI  
**62,00 €**

TIMH/m  
\*6m ΒΕΡΓΑΣ  
**55,80 €**

Code	Product Name	Material	Moment of Inertia		Moment of Resistance		Area	Weight
			I <sub>x</sub>	I <sub>y</sub>	W <sub>x</sub>	W <sub>y</sub>		
<b>M 30/L</b>	90x90 Light	6063	143,13cm <sup>4</sup>	143,13cm <sup>4</sup>	31,80cm <sup>3</sup>	31,80cm <sup>3</sup>	15,20cm <sup>2</sup>	4,12 Kg/m

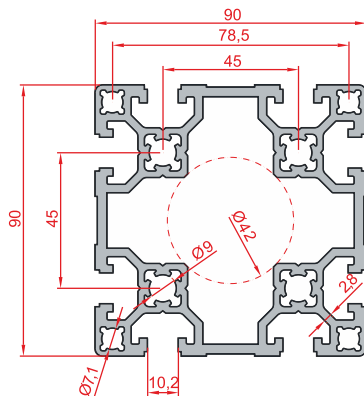

TIMH/m  
KOMMATI  
**81,00 €**

TIMH/m  
\*6m ΒΕΡΓΑΣ  
**73,00 €**

Code	Product Name	Material	Moment of Inertia		Moment of Resistance		Area	Weight
			I <sub>x</sub>	I <sub>y</sub>	W <sub>x</sub>	W <sub>y</sub>		
<b>M 30</b>	90x90	6063	192,84cm <sup>4</sup>	192,84cm <sup>4</sup>	42,8cm <sup>3</sup>	42,8cm <sup>3</sup>	20,67cm <sup>2</sup>	5,60 Kg/m

\*ΕΛΑΧΙΣΤΟ ΜΗΚΟΣ ΚΟΠΗΣ 1200 χιλ. (ΓΙΑ 6ΜΕΤΡΕΣ ΒΕΡΓΕΣ)

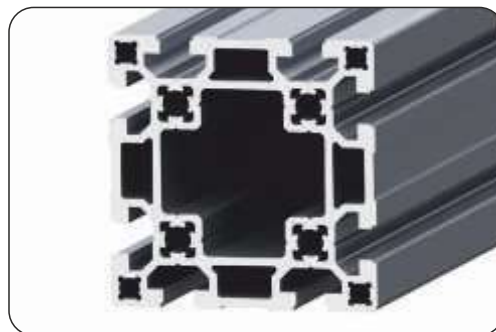
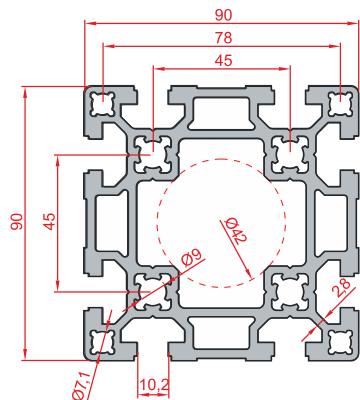

TIMH/m  
KOMMATI

97,00 €

TIMH/m  
\*6m ΒΕΡΓΑΣ

87,30 €

Code	Product Name	Material	Moment of Inertia		Moment of Resistance		Area	Weight
			I <sub>x</sub>	I <sub>y</sub>	W <sub>x</sub>	W <sub>y</sub>		
<b>M 30/A</b>	90x90 Heavy	6063	220,49cm <sup>4</sup>	220,49cm <sup>4</sup>	48,9cm <sup>3</sup>	48,9cm <sup>3</sup>	25,31cm <sup>2</sup>	6,86 Kg/m

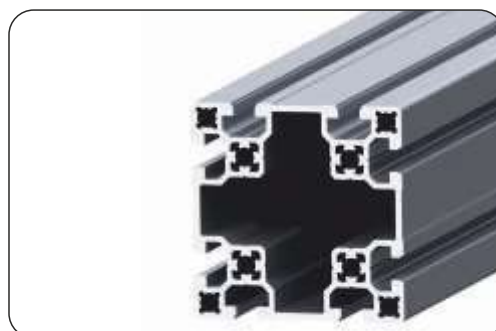
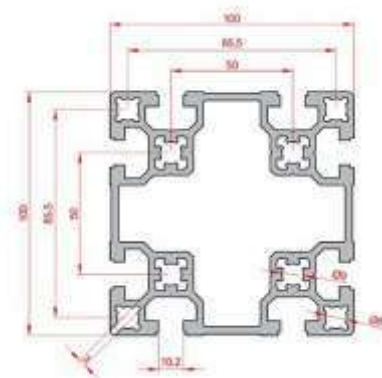
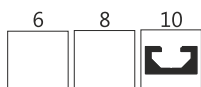

TIMH/m  
KOMMATI

108,50 €

TIMH/m  
\*6m ΒΕΡΓΑΣ

97,65 €

Code	Product Name	Material	Moment of Inertia		Moment of Resistance		Area	Weight
			I <sub>x</sub>	I <sub>y</sub>	W <sub>x</sub>	W <sub>y</sub>		
<b>MG 100</b>	100 X 100	6063-T5	295,4 cm <sup>4</sup>	295,4 cm <sup>4</sup>	cm <sup>3</sup>	cm <sup>4</sup>	25,5 cm <sup>2</sup>	6,91Kg/m

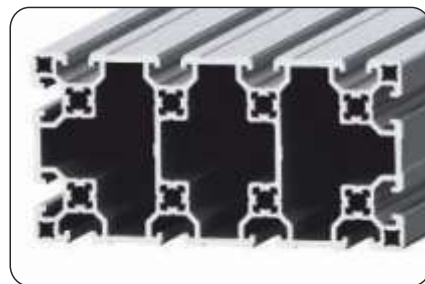
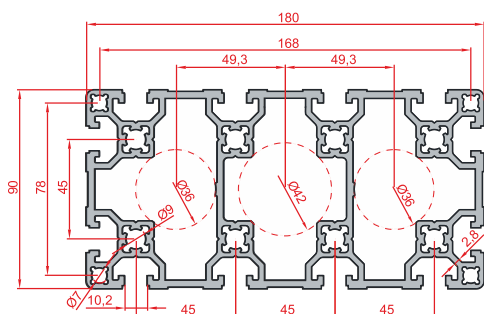
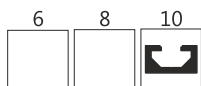

TIMH/m  
KOMMATI

156,00 €

TIMH/m  
\*6m ΒΕΡΓΑΣ

140,50 €

Code	Product Name	Material	Moment of Inertia		Moment of Resistance		Area	Weight
			I <sub>x</sub>	I <sub>y</sub>	W <sub>x</sub>	W <sub>y</sub>		
<b>M 14/L</b>	90x180	6063	1240,6cm <sup>4</sup>	361,5cm <sup>4</sup>	137,8cm <sup>3</sup>	80,3cm <sup>3</sup>	37,1cm <sup>2</sup>	10,04 Kg/m

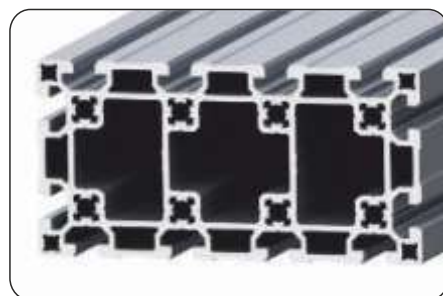
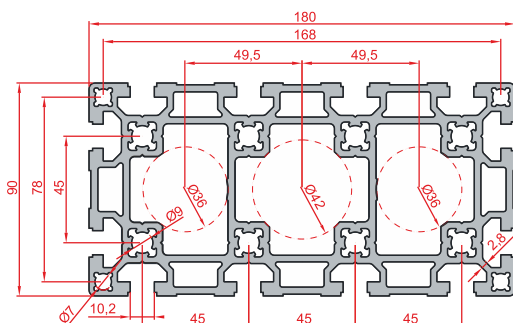

TIMH/m  
KOMMATI

180,00 €

TIMH/m  
\*6m ΒΕΡΓΑΣ

162,00 €

Code	Product Name	Material	Moment of Inertia		Moment of Resistance		Area	Weight
			I <sub>x</sub>	I <sub>y</sub>	W <sub>x</sub>	W <sub>y</sub>		
<b>M 14</b>	90x180 Heavy	6063	1499cm <sup>4</sup>	427,6cm <sup>4</sup>	166,5cm <sup>3</sup>	95,02cm <sup>3</sup>	46,7cm <sup>2</sup>	12,69 Kg/m

\*ΕΛΑΧΙΣΤΟ ΜΗΚΟΣ ΚΟΠΗΣ 1200 χιλ. (ΓΙΑ 6ΜΕΤΡΕΣ ΒΕΡΓΕΣ)

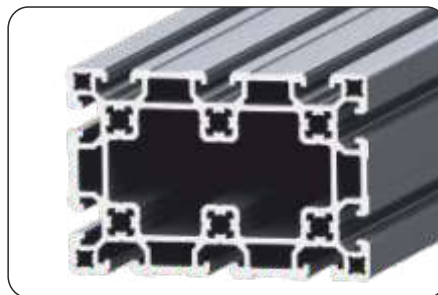
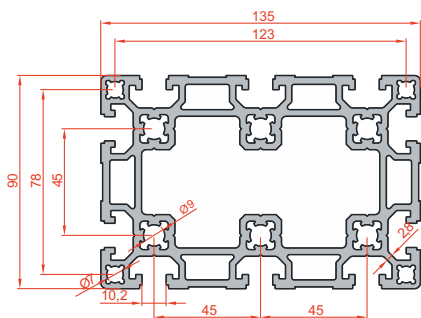
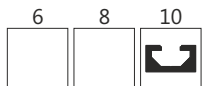

TIMH/m  
KOMMATI  
**145,00 €**

TIMH/m  
\*6m ΒΕΡΓΑΣ  
**130,50 €**

Code	Product Name	Material	Moment of Inertia		Moment of Resistance		Volume	Weight
			$I_x$	$I_y$	$W_x$	$W_y$		
<b>M 32/A</b>	90x135	6063	313,64cm <sup>4</sup>	653cm <sup>4</sup>	69,18cm <sup>3</sup>	96,74cm <sup>3</sup>	34,42cm <sup>2</sup>	9,33 Kg/m

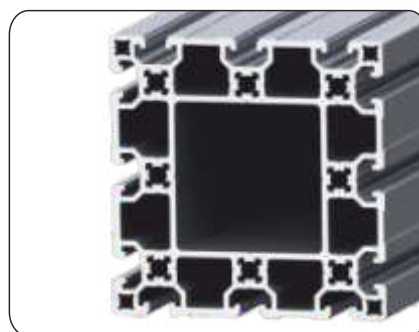
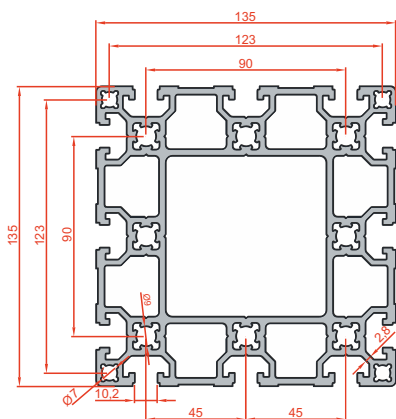
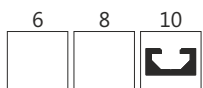

TIMH/m  
KOMMATI  
**189,00 €**

TIMH/m  
\*6m ΒΕΡΓΑΣ  
**170,00 €**

Code	Product Name	Material	Moment of Inertia		Moment of Resistance		Volume	Weight
			$I_x$	$I_y$	$W_x$	$W_y$		
<b>M 32</b>	135x135	6063	897,64cm <sup>4</sup>	897,64cm <sup>4</sup>	132,91cm <sup>3</sup>	132,91cm <sup>3</sup>	44,52cm <sup>2</sup>	12,06 Kg/m

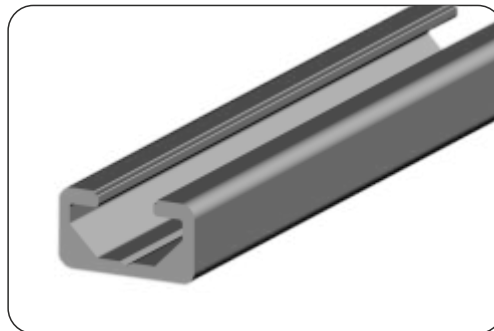
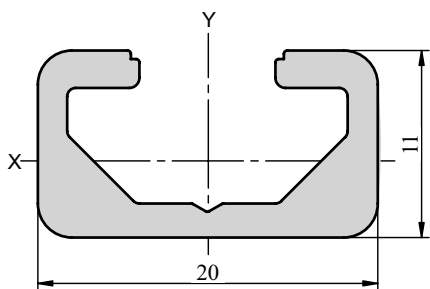

Code	Product Name	Material	Moment of Inertia		Moment of Resistance		Volume	Weight
			$I_x$	$I_y$	$W_x$	$W_y$		
<b>AL 112</b>	11x20	6063	0,13cm <sup>4</sup>	0,52cm <sup>4</sup>	0,20cm <sup>3</sup>	0,52 cm <sup>3</sup>	1,02 cm <sup>2</sup>	0,28 Kg/m

TIMH  
\*2m ΒΕΡΓΑΣ  
**20,00 €**

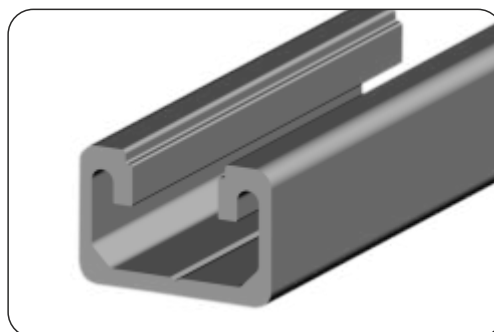
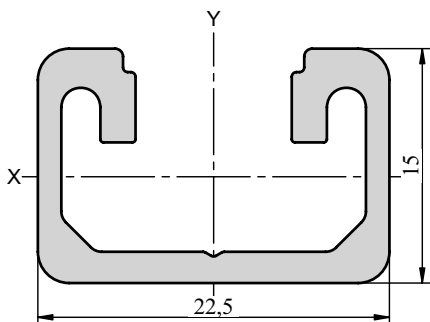

\*ΠΩΛΕΙΤΑΙ ΜΟΝΟ 2 ΜΕΤΡΗ ΒΕΡΓΑ

Code	Product Name	Material	Moment of Inertia		Moment of Resistance		Volume	Weight
			$I_x$	$I_y$	$W_x$	$W_y$		
<b>AL 152</b>	15x22.5	6063	0,33 cm <sup>4</sup>	0,81 cm <sup>4</sup>	0,40 cm <sup>3</sup>	0,72 cm <sup>3</sup>	1,21 cm <sup>2</sup>	0,33 Kg/m

TIMH  
\*3m ΒΕΡΓΑΣ  
**29,50 €**

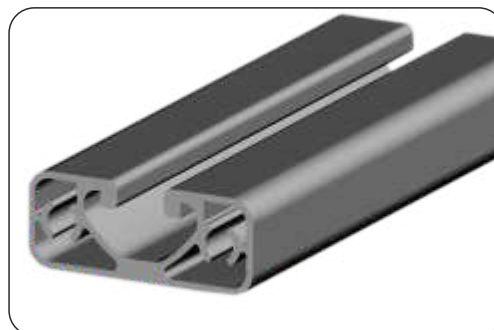
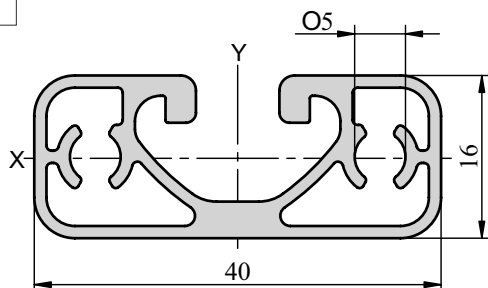
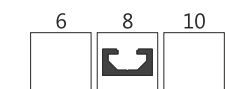

\*ΠΩΛΕΙΤΑΙ ΜΟΝΟ 3 ΜΕΤΡΗ ΒΕΡΓΑ

Code	Product Name	Material	Moment of Inertia		Moment of Resistance		Volume	Weight
			$I_x$	$I_y$	$W_x$	$W_y$		
<b>AL 164</b>	16x40	6063	0,69cm <sup>4</sup>	3,71 cm <sup>4</sup>	0,84 cm <sup>3</sup>	1,86 cm <sup>3</sup>	2,45 cm <sup>2</sup>	0,66 Kg/m

TIMH/m  
ΚΟΜΜΑΤΙ  
**12,20 €**

TIMH/m  
\*3m ΒΕΡΓΑΣ  
**11,00 €**

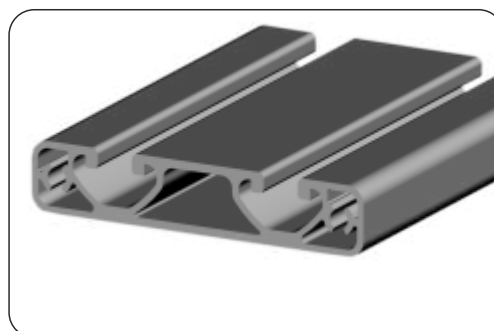
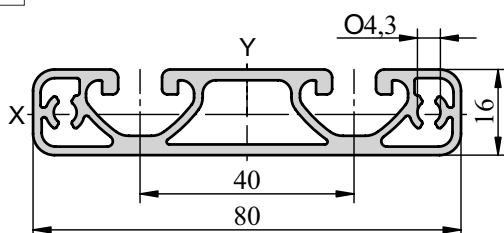
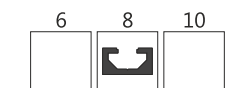

\*ΕΛΑΧΙΣΤΟ ΜΗΚΟΣ ΚΟΠΗΣ 1000 χιλ. (ΓΙΑ 3ΜΕΤΡΕΣ ΒΕΡΓΕΣ)

Code	Product Name	Material	Moment of Inertia		Moment of Resistance		Volume	Weight
			$I_x$	$I_y$	$W_x$	$W_y$		
<b>AL 168</b>	16x80	6063	1,57cm <sup>4</sup>	31,32 cm <sup>4</sup>	1,89 cm <sup>3</sup>	7,83 cm <sup>3</sup>	4,98 cm <sup>2</sup>	1,34 Kg/m

TIMH/m  
ΚΟΜΜΑΤΙ  
**24,50 €**

TIMH/m  
\*3m ΒΕΡΓΑΣ  
**22,05 €**

\*ΕΛΑΧΙΣΤΟ ΜΗΚΟΣ ΚΟΠΗΣ 1000 χιλ. (ΓΙΑ 3ΜΕΤΡΕΣ ΒΕΡΓΕΣ)

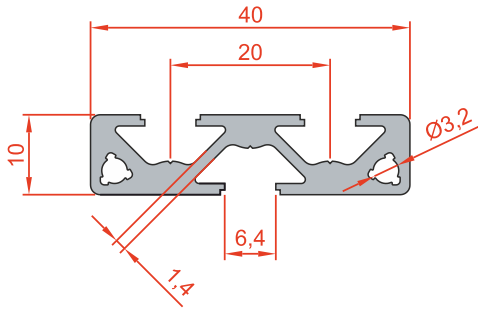
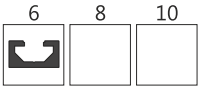

TIMH/m  
KOMMATI  
**9,00 €**

Code	Product Name	Material	Moment of Inertia		Moment of Resistance		Area	Weight
			$I_x$	$I_y$	$W_x$	$W_y$		
<b>FC 40</b>	10x40	6063	3,37cm <sup>4</sup>	0,20cm <sup>4</sup>	1,68cm <sup>3</sup>	0,40cm <sup>3</sup>	2,04cm <sup>2</sup>	0,55 Kg/m

TIMH/m  
\*6m ΒΕΡΓΑΣ  
**8,10 €**

\*ΕΛΑΧΙΣΤΟ ΜΗΚΟΣ ΚΟΠΗΣ 1200 χιλ. (ΓΙΑ 6ΜΕΤΡΕΣ ΒΕΡΓΕΣ)

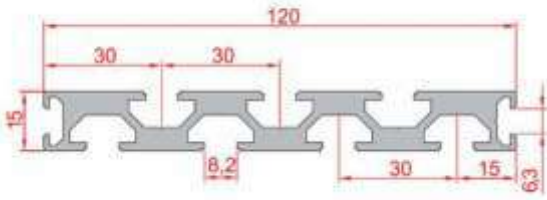

TIMH/m  
KOMMATI  
**34,20 €**

Code	Product Name	Material	Moment of Inertia		Moment of Resistance		Area	Weight
			$I_x$	$I_y$	$W_x$	$W_y$		
<b>M 17</b>	15x120	6063	105,7cm <sup>4</sup>	2,1cm <sup>4</sup>	17,6 cm <sup>3</sup>	2,8 cm <sup>3</sup>	8,6 cm <sup>2</sup>	2,33 Kg/m

TIMH/m  
\*6m ΒΕΡΓΑΣ  
**30,80 €**

\*ΕΛΑΧΙΣΤΟ ΜΗΚΟΣ ΚΟΠΗΣ 1200 χιλ. (ΓΙΑ 6ΜΕΤΡΕΣ ΒΕΡΓΕΣ)

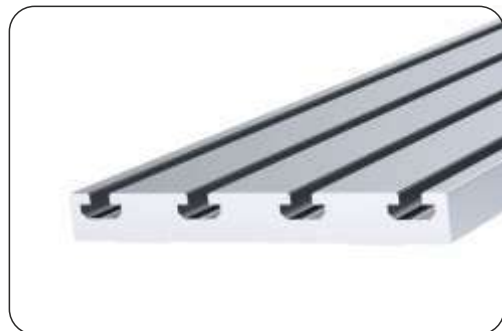
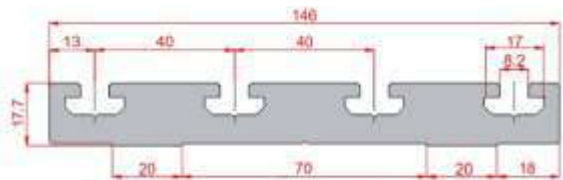

TIMH/m  
KOMMATI  
**110,00 €**

Code	Product Name	Material	Moment of Inertia		Moment of Resistance		Area	Weight
			$I_x$	$I_y$	$W_x$	$W_y$		
<b>AL 146</b>	17,7x146	6063	108,3 cm <sup>4</sup>	2,7cm <sup>4</sup>	19,2 cm <sup>3</sup>	3,2 cm <sup>3</sup>	9,1 cm <sup>2</sup>	5,626 Kg/m

TIMH/m  
\*6m ΒΕΡΓΑΣ  
**99,00 €**

\*ΕΛΑΧΙΣΤΟ ΜΗΚΟΣ ΚΟΠΗΣ 1200 χιλ. (ΓΙΑ 6ΜΕΤΡΕΣ ΒΕΡΓΕΣ)

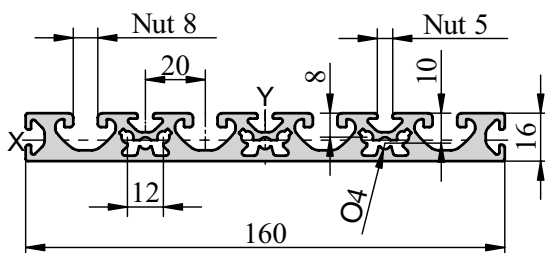
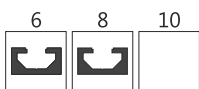

TIMH/m  
KOMMATI  
**75,00 €**

Code	Product Name	Material	Moment of Inertia		Moment of Resistance		Area	Weight
			$I_x$	$I_y$	$W_x$	$W_y$		
<b>AL 160</b>	16x160	6063	3,76cm <sup>4</sup>	304,4cm <sup>4</sup>	4,19cm <sup>3</sup>	38,05cm <sup>3</sup>	15,25cm <sup>2</sup>	3,70 Kg/m

TIMH/m  
\*6m ΒΕΡΓΑΣ  
**67,50 €**

\*ΕΛΑΧΙΣΤΟ ΜΗΚΟΣ ΚΟΠΗΣ 1000 χιλ. (ΓΙΑ 3ΜΕΤΡΕΣ ΒΕΡΓΕΣ)



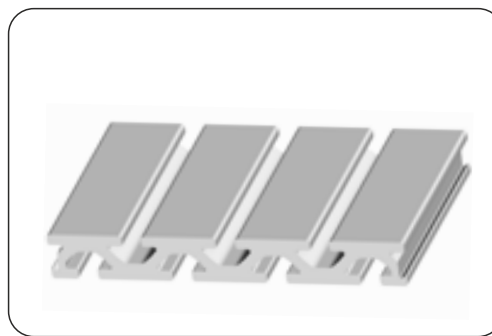
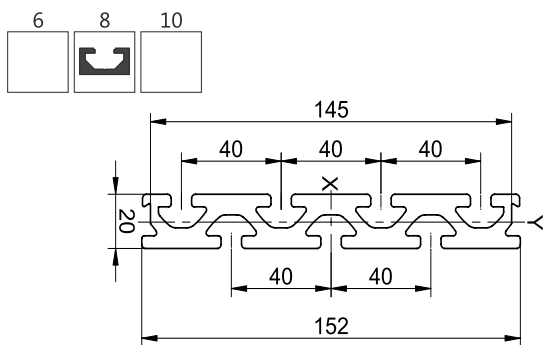

TIMH/m  
KOMMATI  
**84,00 €**

Code	Product Name	Material	Moment of Inertia		Moment of Resistance		Area	Weight
			$I_x$	$I_y$	$W_x$	$W_y$		
<b>MF 17</b>	20x152	6063	7,56 <sup>4</sup>	350,58 <sup>4</sup>	7,35 <sup>3</sup>	46,19 <sup>3</sup>	18,27 <sup>2</sup>	4,93 kg/m

TIMH/m  
\*6m ΒΕΡΓΑΣ  
**75,60 €**

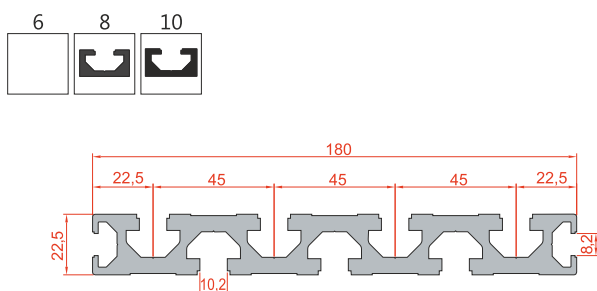

TIMH/m  
KOMMATI  
**90,00 €**

Code	Product Name	Material	Moment of Inertia		Moment of Resistance		Area	Weight
			$I_x$	$I_y$	$W_x$	$W_y$		
<b>M 16</b>	22,5x180	6063	570,9cm <sup>4</sup>	11,7cm <sup>4</sup>	63,43cm <sup>3</sup>	10,4cm <sup>3</sup>	21,1cm <sup>2</sup>	5,73 Kg/m

TIMH/m  
\*6m ΒΕΡΓΑΣ  
**81,00 €**

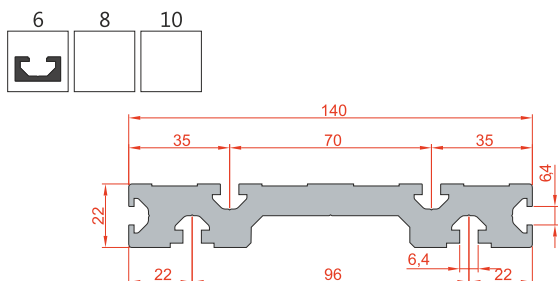

TIMH/m  
KOMMATI  
**89,00 €**

Code	Product Name	Material	Moment of Inertia		Moment of Resistance		Area	Weight
			$I_x$	$I_y$	$W_x$	$W_y$		
<b>M 15 ZE</b>	22x140	6063	365cm <sup>4</sup>	7,2cm <sup>4</sup>	52,14cm <sup>3</sup>	6,54cm <sup>3</sup>	19,8cm <sup>2</sup>	5,38 Kg/m

TIMH/m  
\*6m ΒΕΡΓΑΣ  
**80,10 €**

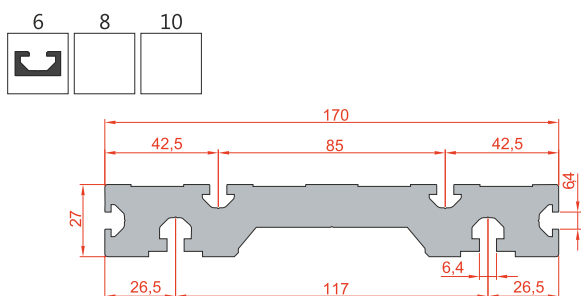

TIMH/m  
KOMMATI  
**147,00 €**

Code	Product Name	Material	Moment of Inertia		Moment of Resistance		Area	Weight
			$I_x$	$I_y$	$W_x$	$W_y$		
<b>M 20 ZE</b>	27x170	6063	852cm <sup>4</sup>	16,8cm <sup>4</sup>	100,2cm <sup>3</sup>	12,4cm <sup>3</sup>	32,44cm <sup>2</sup>	8,79 Kg/m

TIMH/m  
\*6m ΒΕΡΓΑΣ  
**132,30 €**

\*ΕΛΑΧΙΣΤΟ ΜΗΚΟΣ ΚΟΠΗΣ 1200 χιλ. (ΓΙΑ 6ΜΕΤΡΕΣ ΒΕΡΓΕΣ)

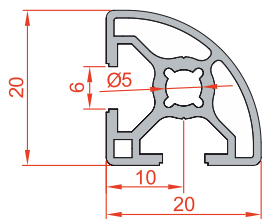

TIMH/m  
KOMMATI  
**5,70 €**

Code	Product Name	Material	Moment of Inertia		Moment of Resistance		Area	Weight
			$I_x$	$I_y$	$W_x$	$W_y$		
<b>M 63/R</b>	20x20 Radius	6063	0,65 cm <sup>4</sup>	0,65 cm <sup>4</sup>	0,61cm <sup>3</sup>	0,61cm <sup>3</sup>	1,42 cm <sup>2</sup>	0,39 Kg/m

TIMH/m  
\*6m ΒΕΡΓΑΣ  
**5,15 €**

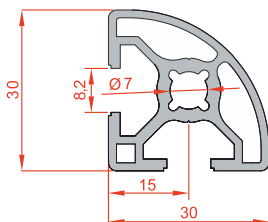

TIMH/m  
KOMMATI  
**11,70 €**

Code	Product Name	Material	Moment of Inertia		Moment of Resistance		Area	Weight
			$I_x$	$I_y$	$W_x$	$W_y$		
<b>M 22/R</b>	30x30 Radius	6063	2,15 cm <sup>4</sup>	2,15 cm <sup>4</sup>	1,30cm <sup>3</sup>	1,30cm <sup>3</sup>	2,78 cm <sup>2</sup>	0,75 Kg/m

TIMH/m  
\*6m ΒΕΡΓΑΣ  
**10,55 €**

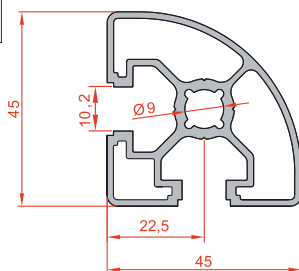

TIMH/m  
KOMMATI  
**18,30 €**

Code	Product Name	Material	Moment of Inertia		Moment of Resistance		Area	Weight
			$I_x$	$I_y$	$W_x$	$W_y$		
<b>M 21/R</b>	45x45 Radius	6063	8,5 cm <sup>4</sup>	8,5 cm <sup>4</sup>	3,38cm <sup>3</sup>	3,38cm <sup>3</sup>	4,46 cm <sup>2</sup>	1,21 Kg/m

TIMH/m  
\*6m ΒΕΡΓΑΣ  
**16,50 €**

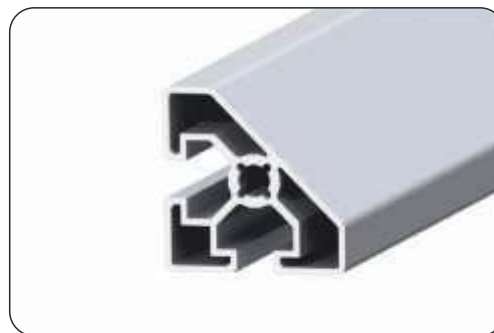
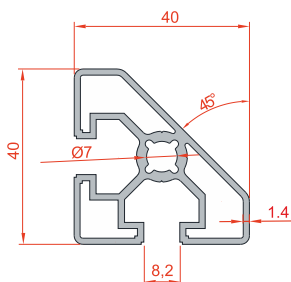

TIMH/m  
KOMMATI  
**14,85 €**

Code	Product Name	Material	Moment of Inertia		Moment of Resistance		Area	Weight
			$I_x$	$I_y$	$W_x$	$W_y$		
<b>M 39/A</b>	40x40 (45°)	6063	4,4cm <sup>4</sup>	4,4cm <sup>4</sup>	1,90cm <sup>3</sup>	1,90cm <sup>3</sup>	3,43cm <sup>2</sup>	0,93 Kg/m

TIMH/m  
\*6m ΒΕΡΓΑΣ  
**13,35 €**

\*ΕΛΑΧΙΣΤΟ ΜΗΚΟΣ ΚΟΠΗΣ 1200 χιλ. (ΓΙΑ 6ΜΕΤΡΕΣ ΒΕΡΓΕΣ)



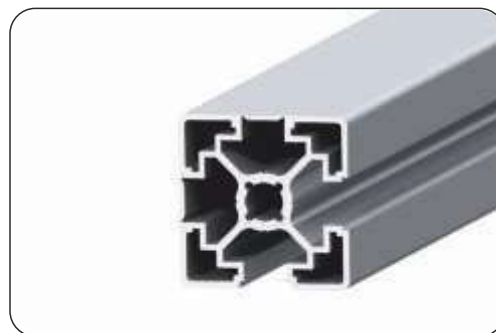
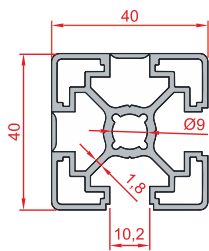

TIMH/m  
KOMMATI  
**18,00 €**

Code	Product Name	Material	Moment of Inertia		Moment of Resistance		Area	Weight
			$I_x$	$I_y$	$W_x$	$W_y$		
<b>M 04-K</b>	40x40 Closed	6063	7,24cm <sup>4</sup>	7,27cm <sup>4</sup>	3,52cm <sup>3</sup>	3,52cm <sup>3</sup>	4,6cm <sup>2</sup>	1,25 Kg/m

TIMH/m  
\*6m ΒΕΡΓΑΣ  
**16,20 €**

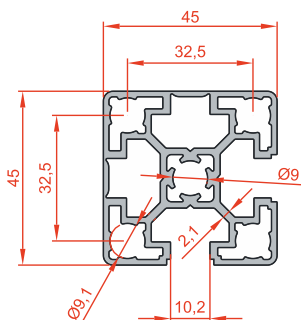

TIMH/m  
KOMMATI  
**22,30 €**

Code	Product Name	Material	Moment of Inertia		Moment of Resistance		Area	Weight
			$I_x$	$I_y$	$W_x$	$W_y$		
<b>M 05-K</b>	45x45 Closed	6063	11,78cm <sup>4</sup>	11,78cm <sup>4</sup>	5,24cm <sup>3</sup>	5,24cm <sup>3</sup>	5,90cm <sup>2</sup>	1,61 Kg/m

TIMH/m  
\*6m ΒΕΡΓΑΣ  
**20,05 €**

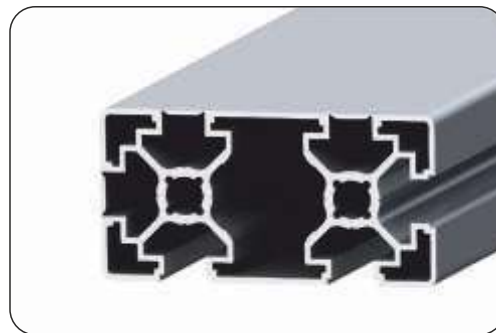
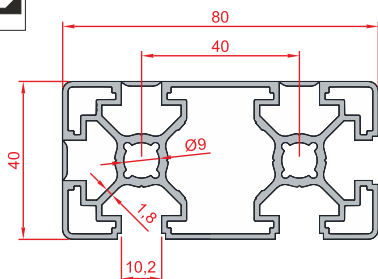

TIMH/m  
KOMMATI  
**31,00 €**

Code	Product Name	Material	Moment of Inertia		Moment of Resistance		Area	Weight
			$I_x$	$I_y$	$W_x$	$W_y$		
<b>M 03-K</b>	40x80 Closed	6063	50,9cm <sup>4</sup>	12,9cm <sup>4</sup>	12,51cm <sup>3</sup>	6,23cm <sup>3</sup>	7,7cm <sup>2</sup>	2,08 Kg/m

TIMH/m  
\*6m ΒΕΡΓΑΣ  
**27,90 €**

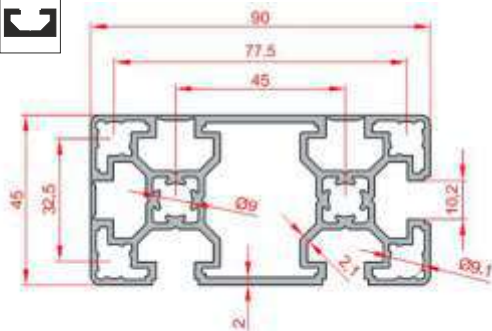

TIMH/m  
KOMMATI  
**41,50 €**

Code	Product Name	Material	Moment of Inertia		Moment of Resistance		Area	Weight
			$I_x$	$I_y$	$W_x$	$W_y$		
<b>M 09-K</b>	45x90 Closed	6063	83,69 cm <sup>4</sup>	22,22 cm <sup>4</sup>	18,59 cm <sup>3</sup>	9,87 cm <sup>3</sup>	10,01 cm <sup>2</sup>	2,74 Kg/m

TIMH/m  
\*6m ΒΕΡΓΑΣ  
**37,35 €**

\*ΕΛΑΧΙΣΤΟ ΜΗΚΟΣ ΚΟΠΗΣ 1200 χιλ. (ΓΙΑ 6ΜΕΤΡΕΣ ΒΕΡΓΕΣ)

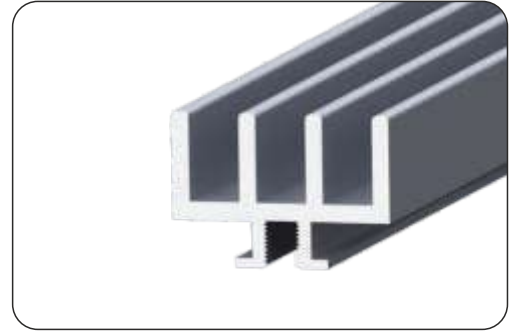
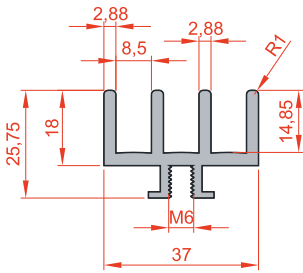

TIMH/m  
KOMMATI

14,50 €

TIMH/m  
\*6m ΒΕΡΓΑΣ

13,05 €

Code	Product Name	Material	Moment of Inertia		Moment of Resistance		Volume	Weight
			$I_x$	$I_y$	$W_x$	$W_y$		
<b>MG 37</b>	SLIDE PROFILE 18 X 37	6063	1,37 cm <sup>4</sup>	4,15 cm <sup>4</sup>	cm <sup>3</sup>	cm <sup>3</sup>	3,37cm <sup>2</sup>	0,89 Kg/m

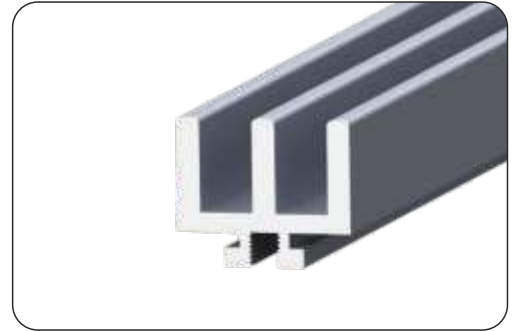
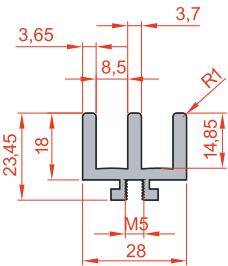
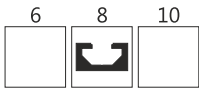

TIMH/m  
KOMMATI

12,50 €

TIMH/m  
\*6m ΒΕΡΓΑΣ

11,25 €

Code	Product Name	Material	Moment of Inertia		Moment of Resistance		Volume	Weight
			$I_x$	$I_y$	$W_x$	$W_y$		
<b>MG 28</b>	SLIDE PROFILE 18 X 28	6063	1,09 cm <sup>4</sup>	2,24 cm <sup>4</sup>	cm <sup>3</sup>	cm <sup>3</sup>	3,37cm <sup>2</sup>	0,77 Kg/m

**ΧΩΡΙΣ ΤΡΥΠΕΣ**



ØD	Κωδικός	Βάρος kg/m	Διαστάσεις (mm)			Μήκος: 6000 χιλιοστά					
			A	H	H1	B	Ød1	C1	C2	K DIN 6912	
12	M DP 12	0,69	40	22 ±0,1	5	29	4,5	50	75	M 4x16	
16	M DP 16	0,84	45	26 ±0,1	5	33	5,5	50	100	M 5x20	
20	M DP 20	1,23	52	32 ±0,1	5,8	37	6,5	50	100	M 6x25	
25	M DP 25	1,44	57	36 ±0,1	6	42	6,5	60	120	M 8x30	
30	M DP 30	2,00	69	42 ±0,15	7	51	8,5	75	150	M 10x35	
40	M DP 40	2,60	73	50 ±0,15	8	55	9	100	200	M 10x40	

TIMH/m  
KOMMATI

11,50 €

TIMH/m  
\*6m ΒΕΡΓΑΣ

10,35 €

14,10 €

12,70 €

20,80 €

18,70 €

23,10 €

20,80 €

32,70 €

29,45 €

43,60 €

39,25 €

\* Στα παραπάνω προφίλ δεν περιλαμβάνονται οι άξονες

\*ΕΛΑΧΙΣΤΟ ΜΗΚΟΣ ΚΟΠΗΣ 1200 χιλ. (ΓΙΑ 6ΜΕΤΡΕΣ ΒΕΡΓΕΣ)

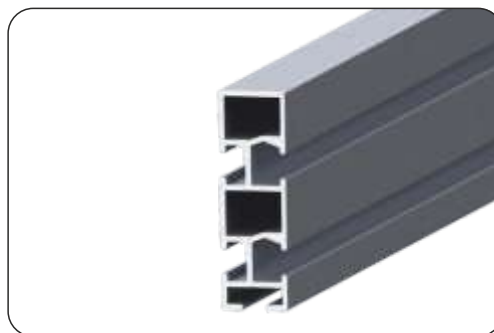
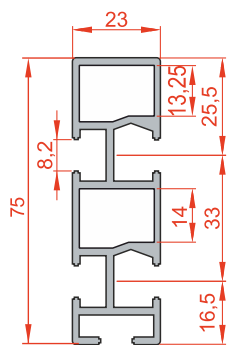

TIMH/m  
KOMMATI  
**20,50 €**

Code	Product Name	Material	Moment of Inertia		Moment of Resistance		Area	Weight
			$I_x$	$I_y$	$W_x$	$W_y$		
<b>M 24/D</b>	23x75	6063	3,11cm <sup>4</sup>	26,03cm <sup>4</sup>	3,65cm <sup>3</sup>	3,65cm <sup>3</sup>	4,86cm <sup>2</sup>	1,32 Kg/m

TIMH/m  
\*6m ΒΕΡΓΑΣ  
**18,45 €**

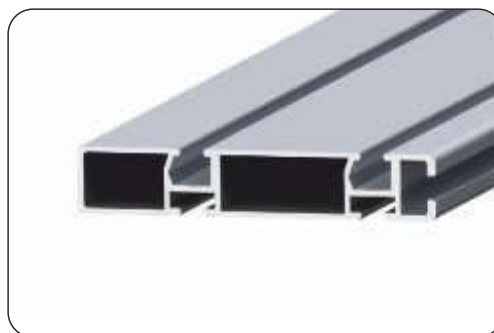
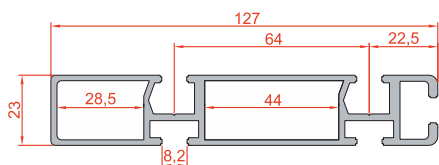

TIMH/m  
KOMMATI  
**29,50 €**

Code	Product Name	Material	Moment of Inertia		Moment of Resistance		Area	Weight
			$I_x$	$I_y$	$W_x$	$W_y$		
<b>M 29</b>	23x127	6063	114,6cm <sup>4</sup>	5,5cm <sup>4</sup>	17,47cm <sup>3</sup>	4,8cm <sup>3</sup>	7,4cm <sup>2</sup>	2,01 Kg/m

TIMH/m  
\*6m ΒΕΡΓΑΣ  
**26,55 €**

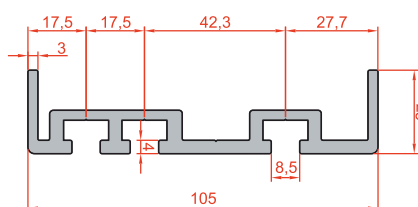

TIMH/m  
KOMMATI  
**33,50 €**

Code	Product Name	Material	Moment of Inertia		Moment of Resistance		Area	Weight
			$I_x$	$I_y$	$W_x$	$W_y$		
<b>M 29/A</b>	25x105	6063	87,1cm <sup>4</sup>	2,4cm <sup>4</sup>	15,07cm <sup>3</sup>	1,49cm <sup>3</sup>	7,45cm <sup>2</sup>	2,01 Kg/m

TIMH/m  
\*6m ΒΕΡΓΑΣ  
**30,15 €**

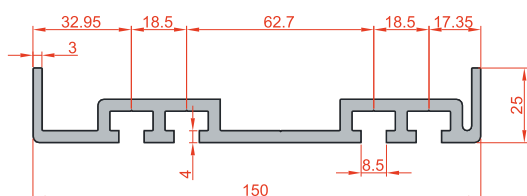

TIMH/m  
KOMMATI  
**44,80 €**

Code	Product Name	Material	Moment of Inertia		Moment of Resistance		Area	Weight
			$I_x$	$I_y$	$W_x$	$W_y$		
<b>M 29/B</b>	25x150	6063	87,1cm <sup>4</sup>	2,4cm <sup>4</sup>	11,46cm <sup>3</sup>	1,9cm <sup>3</sup>	7,45cm <sup>2</sup>	2,90 Kg/m

TIMH/m  
\*6m ΒΕΡΓΑΣ  
**40,30 €**

\*ΕΛΑΧΙΣΤΟ ΜΗΚΟΣ ΚΟΠΗΣ 1200 χιλ. (ΓΙΑ 6ΜΕΤΡΕΣ ΒΕΡΓΕΣ)

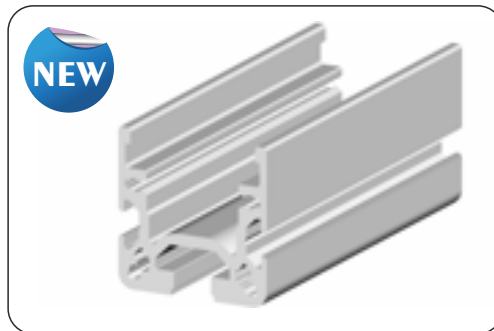
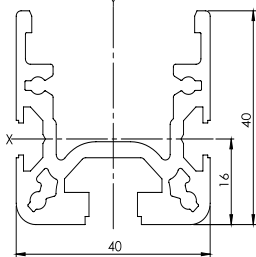

TIMH  
3m ΒΕΡΓΑΣ

65,00 €

TIMH  
6m ΒΕΡΓΑΣ

120,00 €

Code	Product Name	Material	Moment of Inertia		Moment of Resistance		Area	Weight
			$I_x$	$I_y$	$W_x$	$W_y$		
<b>AL 40 RL</b>	40x40 Roller Profile	6063	40,35 cm <sup>4</sup>	28,35 cm <sup>4</sup>	20,07cm <sup>3</sup>	14,05cm <sup>3</sup>	4,98cm <sup>2</sup>	1,36 Kg/m

ΕΠΙΘΥΜΗΤΕΣ ΔΙΑΣΤΑΣΕΙΣ ΚΑΤΟΠΙΝ ΠΑΡΑΓΓΕΛΙΑΣ

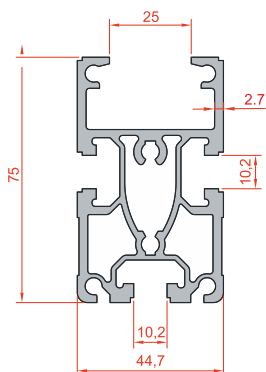

TIMH/m  
ΚΟΜΜΑΤΙ

40,00 €

TIMH/m  
\*6m ΒΕΡΓΑΣ

36,00 €

Code	Product Name	Material	Moment of Inertia		Moment of Resistance		Area	Weight
			$I_x$	$I_y$	$W_x$	$W_y$		
<b>M 24</b>	45x75 Conveyor	6063	23,46cm <sup>4</sup>	45,80cm <sup>4</sup>	10,7cm <sup>3</sup>	9,21cm <sup>3</sup>	9,42cm <sup>2</sup>	2,55 Kg/m

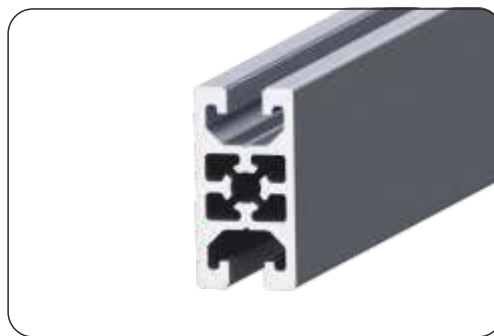
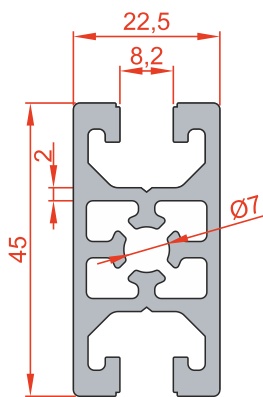

TIMH/m  
ΚΟΜΜΑΤΙ

21,50 €

TIMH/m  
\*6m ΒΕΡΓΑΣ

19,35 €

Code	Product Name	Material	Moment of Inertia		Moment of Resistance		Area	Weight
			$I_x$	$I_y$	$W_x$	$W_y$		
<b>PP 45</b>	Panel Profile 22,5x45	6063	2,95cm <sup>4</sup>	8,15cm <sup>4</sup>	0,42cm <sup>3</sup>	0,82cm <sup>3</sup>	4,63cm <sup>2</sup>	1,25 Kg/m

\*ΕΛΑΧΙΣΤΟ ΜΗΚΟΣ ΚΟΠΗΣ 1200 χιλ. (ΓΙΑ 6ΜΕΤΡΕΣ ΒΕΡΓΕΣ)

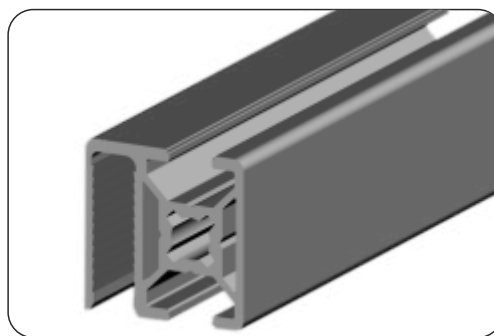
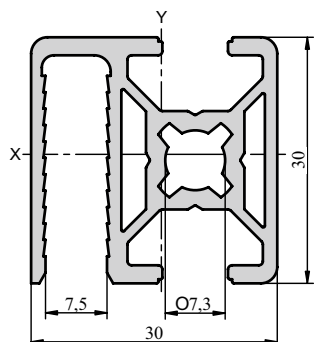
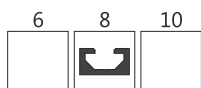

TIMH/m  
ΚΟΜΜΑΤΙ

18,50 €

TIMH/m  
\*3m ΒΕΡΓΑΣ

16,65 €

Code	Product Name	Material	Moment of Inertia		Moment of Resistance		Area	Weight
			$I_x$	$I_y$	$W_x$	$W_y$		
<b>AL 30 SG</b>	Cover Profile 30x30	6063	2,48cm <sup>4</sup>	2,91cm <sup>4</sup>	1,58cm <sup>3</sup>	1,83cm <sup>3</sup>	3,13 cm <sup>2</sup>	0,85 Kg/m

\*ΕΛΑΧΙΣΤΟ ΜΗΚΟΣ ΚΟΠΗΣ 1000 χιλ. (ΓΙΑ 3ΜΕΤΡΕΣ ΒΕΡΓΕΣ)

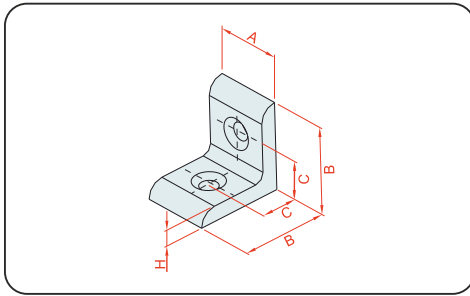

Code	Profile External	Product Name	A	B	C	D	H	Material	Weight
<b>M 53</b>	30x30	Straight Corner Connection	28	22.5	40	Ø6	7	Aluminium	21 gr
<b>M 53/C</b>	40x40	Straight Corner Connection	37	37	20	Ø8.2	6.5	Aluminium	39 gr
<b>M 53/A</b>	45x45	Straight Corner Connection	42	42	22.5	Ø8.2	7	Aluminium	56 gr
<b>M 53/B</b>	80x80	Straight Corner Connection	76	20	76	Ø8.5	8,3	Aluminium	206 gr

TIMH KOMMATI
1,00 €
1,10 €
1,20 €
5,00 €

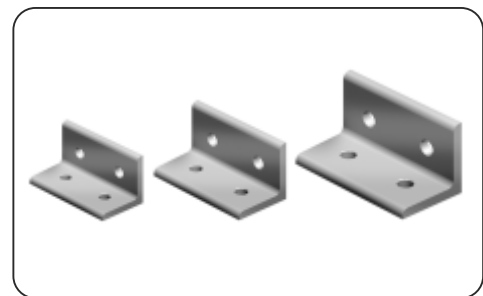
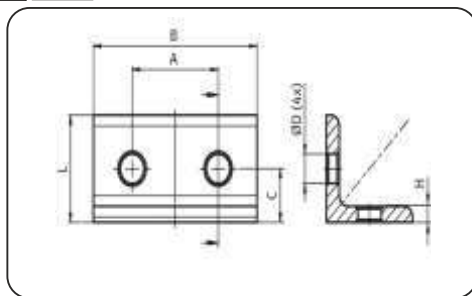

Code	Product Name	A	B	C	H	L	ØD	Material	Weight
<b>MF 20</b>	Angle 20x20x38 (40x20)	20	38	10	3	20	5.5	Aluminium	12 gr
<b>MF 36</b>	Angle 30x30x58 (30x60)	30	57	15	5	30	7	Aluminium	40 gr
<b>MF 40</b>	Angle 40x40x76 (40x80)	25.2	48	12.5	4	25	7	Aluminium	86 gr
<b>MF 45</b>	Angle 45x45x86 (45x90)	45	86	22.5	6	45	9	Aluminium	112 gr

TIMH KOMMATI
1,90 €
3,30 €
4,40 €
5,00 €





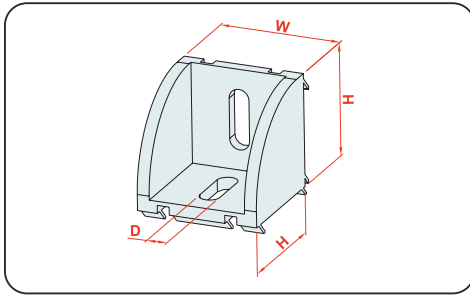

Code	Prof External	Product Name	H	W	D	Material	Weight
<b>M 54/K</b>	20-25	Wide Corner Connection	20	17.5	5	Aluminium	15.5 gr
<b>M 55/G</b>	30x30	Wide Corner Connection	28	28	6.5	Aluminium	41.5 gr
<b>M 55/H</b>	40x40	Wide Corner Connection	37	37.7	9	Aluminium	49 gr
<b>M 55/H8</b>	40x40	Wide Corner Connection S8	37	37.7	9	Aluminium	49 gr
<b>M 54/G</b>	45x45	Wide Corner Connection	44	43	9	Aluminium	75 gr
<b>M 54/F</b>	60x60	Wide Corner Connection	57	57	6.5	Aluminium	98 gr
<b>M 54/I</b>	80x80	Wide Corner Connection	78	77	10	Aluminium	226 gr
<b>M 54/I 8</b>	80x80	Wide Corner Connection S8	78	77	10	Aluminium	226 gr
<b>M 52</b>	90x90	Wide Corner Connection	84.7	86.5	9	Aluminium	366 gr
<b>M 96/K</b>	20-25	Wide Corner Connection Cover	-	-	-	Plastic	2 gr
<b>M 97/G</b>	30x30	Wide Corner Connection Cover	-	-	-	Plastic	4 gr
<b>M 97/A</b>	40x40	Wide Corner Connection Cover	-	-	-	Plastic	8 gr
<b>M 96/G</b>	45x45	Wide Corner Connection Cover	-	-	-	Plastic	10 gr
<b>M 97/B</b>	60x60	Wide Corner Connection Cover	-	-	-	Plastic	8 gr
<b>M 97/C</b>	80x80	Wide Corner Connection Cover	-	-	-	Plastic	27 gr
<b>M 96/D</b>	90x90	Wide Corner Connection Cover	-	-	-	Plastic	24 gr

TIMH KOMMATI
1,10 €
1,60 €
1,70 €
1,80 €
1,90 €
2,50 €
4,50 €
5,10 €
6,00 €
0,50 €
0,60 €
0,70 €
0,80 €
0,90 €
1,00 €
1,20 €



Code	Prof External	Product Name	A	D	Material	Weight
<b>M 55</b>	30x30	Corner Connection Narrow	8	Ø6.5	Aluminium	54 gr
<b>M 54</b>	45x45	Corner Connection Narrow	10	Ø8.5	Aluminium	59 gr
<b>G 45</b>	45x45 30x30	Corner Connection Narrow Cover	-	-	Plastic	7.5 gr

TIMH KOMMATI
1,30 €
1,35 €
0,50 €

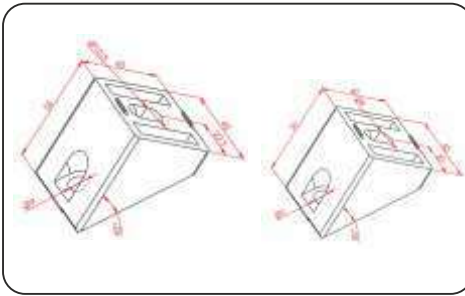
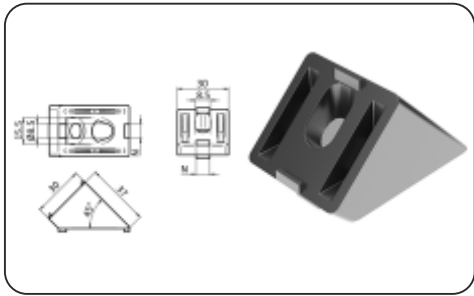

Code	Prof External	Product Name	D	Material	Weight
<b>M 120</b>	40x40	45° Angle Corner Connector	Ø8.5	Aluminium	86 gr
<b>M 121</b>	45x45	45° Angle Corner Connector	Ø10	Aluminium	98 gr
<b>M 123</b>	30x30	45° Angle Corner Connector	Ø8.5	Aluminium	33.5 gr
<b>M 125/S</b>	25x25	40/45° Angle Corner Connector	Ø6.5	Aluminium	30.1 gr

TIMH KOMMATI
2,80 €
3,00 €
2,20 €
2,15 €

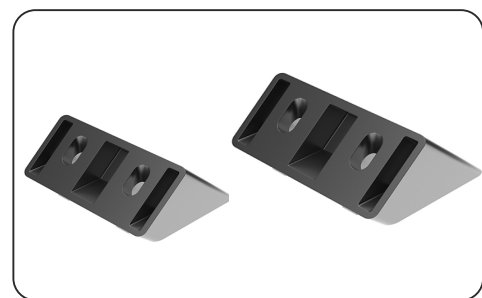
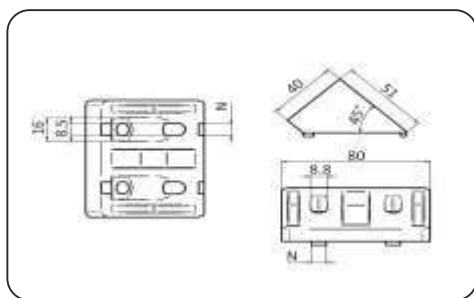

Code	Product Name	A	B	C	H	ØD	Material	Weight
<b>MF 42</b>	Angle Connector 20x40 S6	40	20	16	5	8.5	Aluminium	19.2 gr
<b>MF 60</b>	Angle Connector 30x60 S8	60	30	16.5	8	8.8	Aluminium	41.2 gr
<b>MF 21/SS</b>	Angle Connector 40x80 S8/10	80	40	18	8	8.8	Aluminium	166.2 gr

TIMH KOMMATI
3,00 €
3,90 €
6,80 €

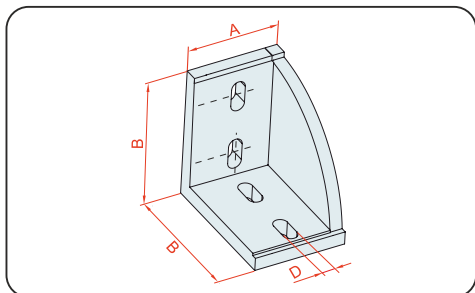

Code	Prof External	Product Name	A	B	D	Malzeme	Weight
<b>M 54/C</b>	30x60	Corner Connection Long	27.2	57	6.5	Aluminium	48 gr
<b>M 54/A</b>	40x80	Corner Connection Long	37.5	78	10.5	Aluminium	114 gr
<b>M 54/U</b>	45x90	Corner Connection Long	42	84.2	9	Aluminium	142 gr
<b>M 54/P</b>	30x60	Corner Connection Long Cover	-	-	-	Plastic	10 gr
<b>M 54/B</b>	40x80	Corner Connection Long Cover	-	-	-	Plastic	10 gr

TIMH KOMMATI
1,50 €
2,30 €
2,80 €
0,70 €
0,80 €

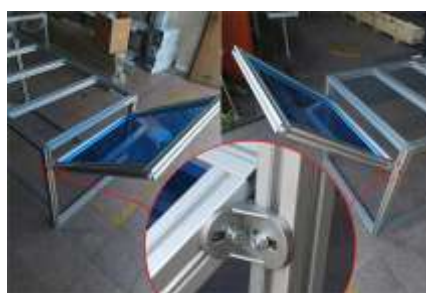
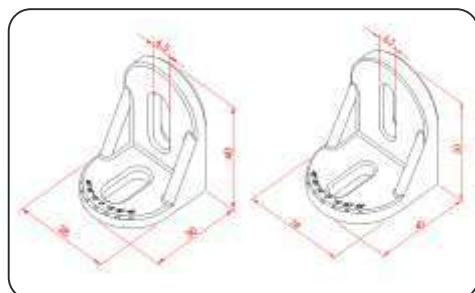

Code	Product Name	A	B	C	D	Malzeme	Weight
<b>MF 3035</b>	Adjustable Corner Bracket 30x35	30	40	28	Ø6.5	Aluminium	21 gr
<b>MF 4045</b>	Adjustable Corner Bracket 40x45	40	50	38	Ø6.5	Aluminium	44 gr

TIMH KOMMATI
1,40 €
1,70 €

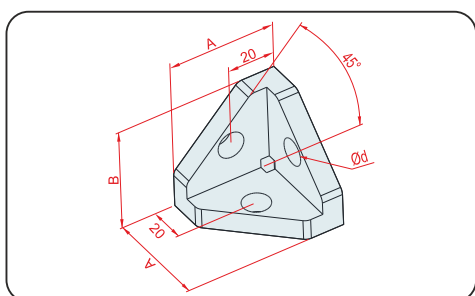

Code	Prof External	Prof External	A	B	D	Material	Weight
<b>M 1/T</b>	40x40 A	Triangle Corner Connection	36	36	Ø8.5	Aluminium	56 gr
<b>M 2/T</b>	40x40 A	Triangle Corner Connection Cover	40	40	-	Plastic	7 gr
<b>M 3/T</b>	40x40	Square Corner Connection Cover	40	40	-	Plastic	13.5 gr

TIMH KOMMATI
2,60 €
0,80 €
1,00 €

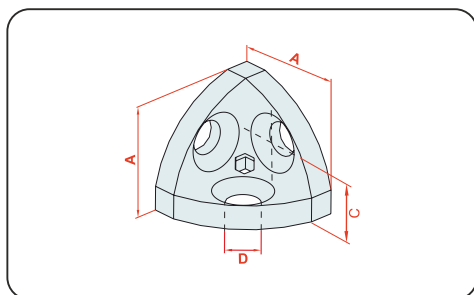

Code	Prof External	Prof External	A	C	D	Material	Weight
<b>M 56/R</b>	20x20	Radius Corner Connection	18.5	10	6.5	Aluminium	12 gr
<b>M 55/R</b>	30x30	Radius Corner Connection	28	15	8.5	Aluminium	42 gr
<b>M 54/R</b>	45x45	Radius Corner Connection	42	22,5	10.5	Aluminium	136 gr
<b>M 96/C</b>	20x20	Radius Corner Connection Cover	20	3	-	Plastic	2 gr
<b>M 96/A</b>	30x30	Radius Corner Connection Cover	30	3	-	Plastic	4 gr
<b>M 96/B</b>	45x45	Radius Corner Connection Cover	45	3	-	Plastic	14 gr
<b>M 87/A</b>	20x20	Square Corner Connection Cover	20	2	-	Plastic	3 gr
<b>M 87/B</b>	30x30	Square Corner Connection Cover	30	3	-	Plastic	8 gr
<b>M 87/C</b>	45x45	Square Corner Connection Cover	45	3	-	Plastic	22 gr

TIMH KOMMATI
1,30 €
1,90 €
2,90 €
0,50 €
0,60 €
0,80 €
0,60 €
0,75 €
0,90 €

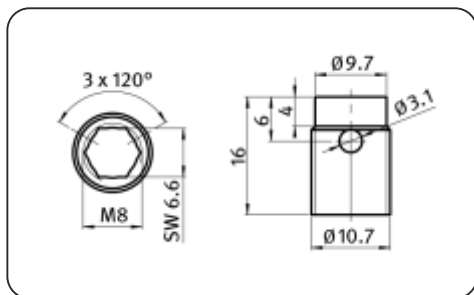

Code	Product Name	A	B	C	Ø D	Ø d	L	M	Material	Weight
<b>MF 801</b>	Cutting Bush with Shank 10	10.7	9.7	16	10.7	9.7	16	8 (3x120°)	Steel zinc	3.8 gr

TIMH KOMMATI
1,50 €

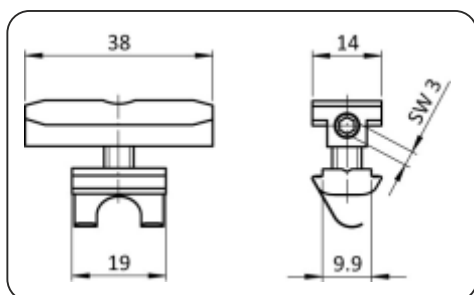
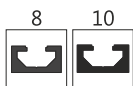

Code	Product Name	A	B	C	M	Ø d	L	Material	Weight
<b>MF 38</b>	Direct Connector B Set S 8/10	9.9	19	14	6	Sw3	38	Steel zinc	36 gr

TIMH KOMMATI
7,00 €

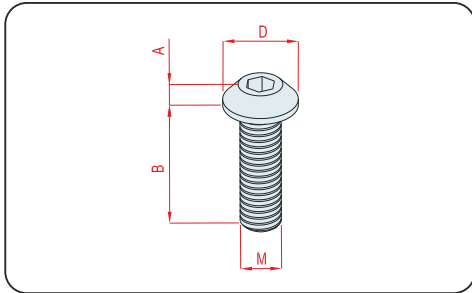

Code		Product Name	M	A	B	ØD	Material	Weight
<b>M 44/C</b>	Slot 6	Head Bolt	M6	3.5	20	10.5	8.8 Steel	4.5 gr
<b>M 44/B</b>	Slot 8	Head Bolt	M8	5.2	25	16	8.8 Steel	13 gr
<b>M 44</b>	Slot 10	Head Bolt	M10	6	30	17.5	8.8 Steel	21 gr

TIMH KOMMATI
0,13 €
0,23 €
0,36 €

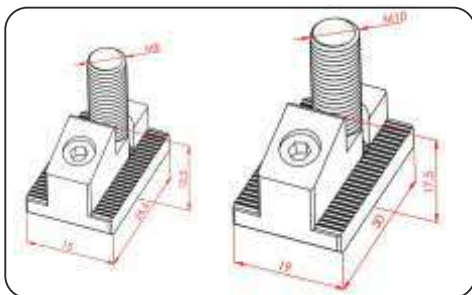

Code		Product Name	M	A	B	C	Material	Weight
<b>M 86/B</b>	Slot 8	Inner Slot Connector	M8	15	26.4	12.5	Steel	15 gr
<b>M 86/J</b>	Slot 10	Inner Slot Connector	M10	19	30	17.5	Steel	27 gr

TIMH KOMMATI
2,95 €
4,00 €



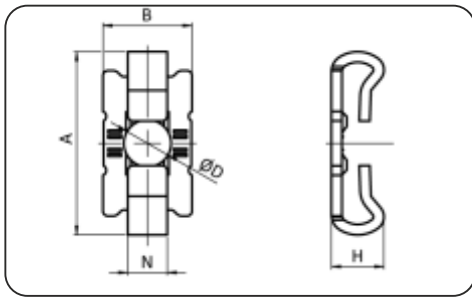

Code	Product Name	A	B	N	H	M	L	Material	Weight
<b>MF IS80</b>	Screw Connector I S8 Double	35	17	9	10	8	35	Steel Zinc	20.7 gr

TIMH  
KOMMATI  
**1,60 €**

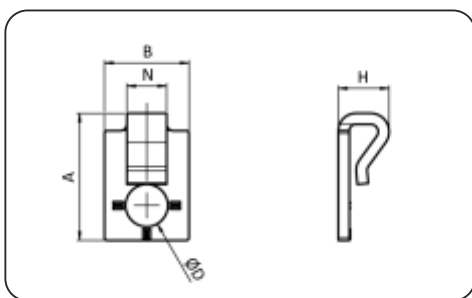

Code	Product Name	A	B	N	H	M	D	Material	Weight
<b>MF IS81</b>	Screw Connector I S8 Single	25.5	17	8	10.2	8	8.5	Steel Zinc	8.6 gr

TIMH  
KOMMATI  
**1,20 €**



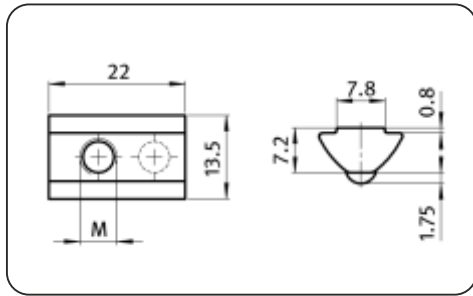

Code	Product Name	A	B	C	D	M	d	L	Material	Weight
<b>MF 322</b>	Modular Nuts M3 S8 Ball	0.8	13.5	7.8	1.75	3	7.2	22	Steel Zinc	10.9 gr

TIMH KOMMATI  
**1,45 €**

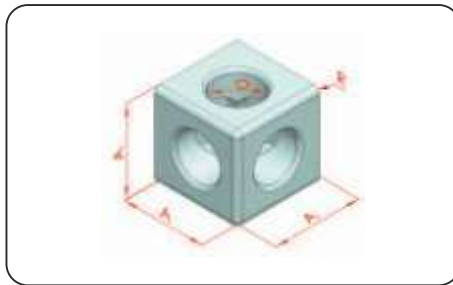

Code	Prof External	Product Name	A	D	R	Material	Weight
<b>M 115</b>	30x30	Three Corner Cube Connector	30	Ø20,5	2	Aluminium	38,5 gr
<b>M 117</b>	40x40 S8	Three Corner Cube Connector	40	Ø26,6	4	Aluminium	94,5 gr
<b>M 117/S10</b>	40x40 S10	Three Corner Cube Connector	40	Ø26,6	4	Aluminium	94,5 gr
<b>M 116</b>	45x45	Three Corner Cube Connector	45	Ø26,6	4	Aluminium	151 gr

TIMH KOMMATI  
**5,00 €**  
**6,70 €**  
**6,50 €**  
**7,00 €**

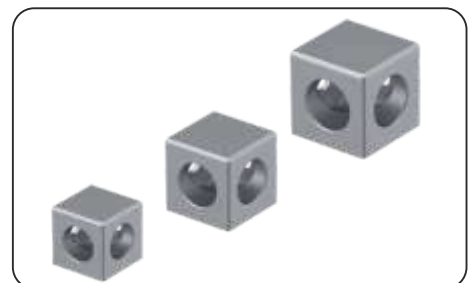
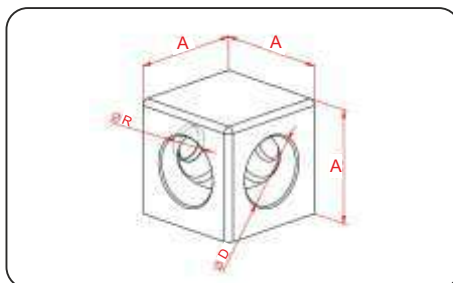
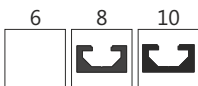

Code	Prof External	Product Name	A	D	R	Material	Weight
<b>M 115/2</b>	30x30	Two Corner Cube Connector	30	Ø18	9	Aluminium	44,26 gr
<b>M 117/2</b>	40x40 S8	Two Corner Cube Connector	40	Ø24	8,5	Aluminium	106,40 gr
<b>M 117/SD</b>	40x40 S10	Two Corner Cube Connector	40	Ø24	12,5	Aluminium	104,88 gr
<b>M 116/2</b>	45x45	Two Corner Cube Connector	45	Ø24	13	Aluminium	168,13 gr

TIMH KOMMATI  
**4,50 €**  
**6,00 €**  
**5,80 €**  
**6,50 €**

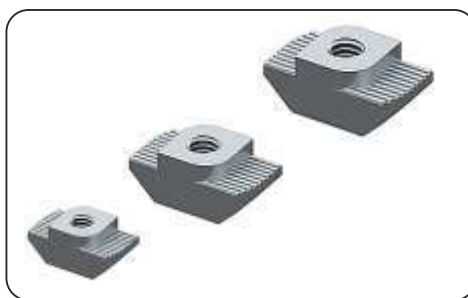
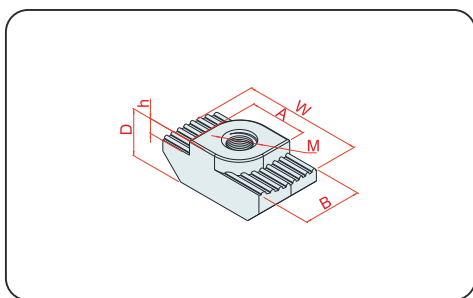

Code	Icon	Product Name	M	B	W	D	H	A	Material	Weight
<b>M 47/A</b>	Slot 6	Jagged Nut	M4	5.7	11.4	4.1	1.2	5.6	8.8 Steel	1.2 gr
<b>M 47/S</b>	Slot 6	Jagged Nut	M5	5.7	11.4	4.1	1.2	5.6	8.8 Steel	1 gr
<b>M 42/B</b>	Slot 8	Jagged Nut	M4	7.9	16	6.3	2	7.7	8.8 Steel	3.6 gr
<b>M 42/A</b>	Slot 8	Jagged Nut	M5	7.9	16	6.3	2	7.7	8.8 Steel	3.3 gr
<b>M 42</b>	Slot 8	Jagged Nut	M6	7.9	16	6.3	2	7.7	8.8 Steel	3 gr
<b>M 43/B</b>	Slot 10	Jagged Nut	M4	10	19	8.7	3	9.8	8.8 Steel	7.5 gr
<b>M 43/A</b>	Slot 10	Jagged Nut	M5	10	19	8.7	3	9.8	8.8 Steel	7 gr
<b>M 43</b>	Slot 10	Jagged Nut	M6	10	19	8.7	3	9.8	8.8 Steel	6.5 gr
<b>M 41</b>	Slot 10	Jagged Nut	M8	10	19	8.7	3	9.8	8.8 Steel	5.5 gr
<b>M 42/SS</b>	Slot 8	Jagged Nut Inox	M6	7.9	16	6.3	2	7.7	Stainless Steel	2.7 gr
<b>M 43/SS</b>	Slot 10	Jagged Nut Inox	M6	10	19	8.7	3	9.8	Stainless Steel	5.9 gr
<b>M 41/SS</b>	Slot 10	Jagged Nut Inox	M8	10	19	8.7	3	9.8	Stainless Steel	5 gr

TIMH KOMMATI
0,23 €
0,23 €
0,25 €
0,25 €
0,25 €
0,27 €
0,27 €
0,27 €
0,27 €
0,85 €
0,95 €
0,95 €

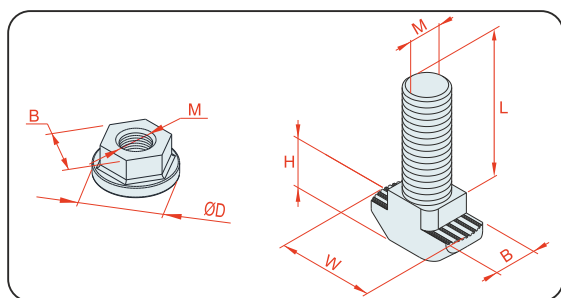
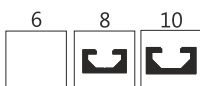

Code	Icon	Product Name	D	L	M	H	W	B	Material	Weight
<b>M 40/B</b>	Slot 8	M6x20 Hammer Screw Nut	-	18,5	6	6,8	16,5	7,7	8.8 Steel	7.5 gr
<b>M 40/G</b>	Slot 8	M6x25 Hammer Screw Nut	-	23,5	6	6,8	16,5	7,7	8.8 Steel	8 gr
<b>M 40/C</b>	Slot 10	M8x25 Hammer Screw Nut	-	17	8	9,7	19,5	8,3	8.8 Steel	14 gr
<b>M 40/A</b>	Slot 10	M8x30 Hammer Screw Nut	-	27	8	9,7	19,5	8,3	8.8 Steel	16 gr
<b>M 40/D</b>	Slot 10	M8x40 Hammer Screw Nut	-	37	8	9,7	19,5	8,3	8.8 Steel	18.5 gr
<b>M 40/F</b>	Slot 10	M8x60 Hammer Screw Nut	-	57	8	9,7	19,5	8,3	8.8 Steel	25.5 gr
<b>M 40/E</b>	Slot 8	Round Head Bolt	Ø13	-	6	-	-	9,8	8.8 Steel	3 gr
<b>M 40/I</b>	Slot 10	Round Head Bolt	Ø21	-	8	-	-	12,7	8.8 Steel	9,5 gr

TIMH KOMMATI
0,30 €
0,35 €
0,40 €
0,45 €
0,50 €
0,60 €
0,10 €
0,15 €



## Fasteners

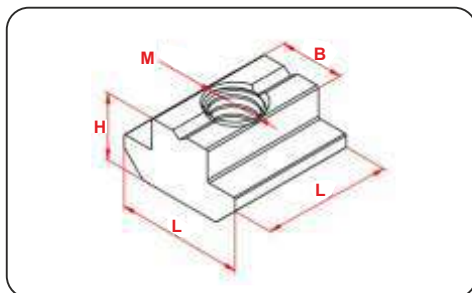

## Small Nuts

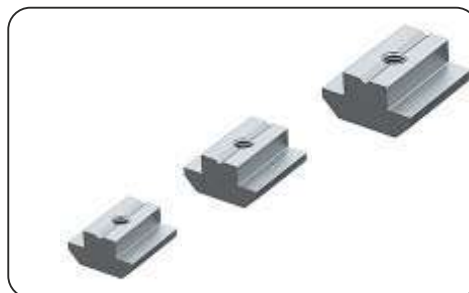

Code		Product Name	M	B	L	H	Material	Weight
<b>M 102 T</b>	Slot 6	Small Nuts	M4	6	10	5	8.8 Steel	2.5 gr
<b>M 102 R</b>	Slot 6	Small Nuts	M5	6	10	5	8.8 Steel	2 gr
<b>M 102 Z</b>	Slot 6	Small Nuts	M6	6	10	5	8.8 Steel	2 gr
<b>M 102 P</b>	Slot 8	Small Nuts	M4	7.8	16	6	8.8 Steel	9 gr
<b>M 102 L</b>	Slot 8	Small Nuts	M5	7.8	16	6	8.8 Steel	8.5 gr
<b>M 102 F</b>	Slot 8	Small Nuts	M6	7.8	16	6	8.8 Steel	8.5 gr
<b>M 102 E</b>	Slot 8	Small Nuts	M8	7.8	16	6	8.8 Steel	7.5 gr
<b>M 102 D</b>	Slot 10	Small Nuts	M4	10.1	20	10,5	8.8 Steel	21.5 gr
<b>M 102 C</b>	Slot 10	Small Nuts	M5	10.1	20	10,5	8.8 Steel	20.5 gr
<b>M 102 B</b>	Slot 10	Small Nuts	M6	10.1	20	10,5	8.8 Steel	19.5 gr
<b>M 102 A</b>	Slot 10	Small Nuts	M8	10.1	20	10,5	8.8 Steel	18.5 gr
<b>MF 101</b>	Slot 10	Small Nuts	M10	10	20	10.6	8.8 Steel	20.9 gr

TIMH KOMMATI
0,32 €
0,32 €
0,32 €
0,42 €
0,42 €
0,42 €
0,42 €
0,48 €
0,48 €
0,48 €
0,48 €
0,90 €

## Fasteners

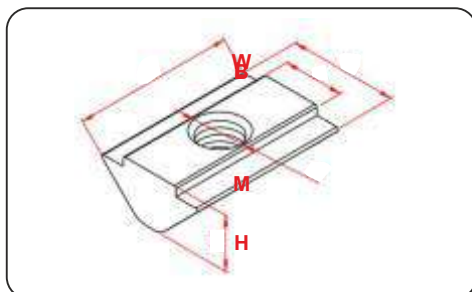

## Modular T Slot Nuts



Code		Product Name	M	B	W	L	H	Material	Weight
<b>M 105</b>	Slot 6	Modular T Slot Nut	M4	6.1	11	16	5.5	8.8 Steel	4 gr
<b>M 105/A</b>	Slot 6	Modular T Slot Nut	M5	6.1	11	16	5.5	8.8 Steel	4 gr
<b>M 105/B</b>	Slot 6	Modular T Slot Nut	M6	6.1	11	16	5.5	8.8 Steel	3 gr

TIMH KOMMATI
0,30 €
0,30 €
0,30 €

## Fasteners

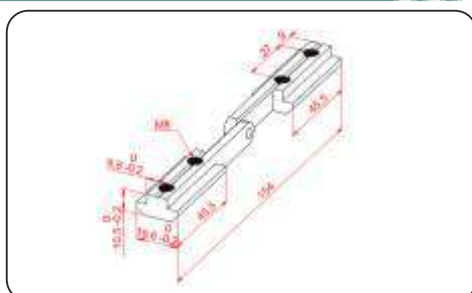

## Joint Nuts



Code		Product Name	M	B	W	L	H	Material	Weight
<b>M 107 D</b>	Slot 10	Vertical great joint nut	M8	45.5	19.6	154	10.05	Carbon steel	110 gr

TIMH KOMMATI
10,50 €

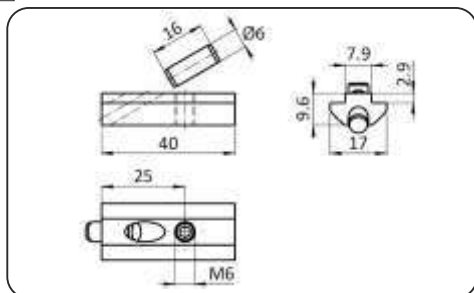

Code	Icon	Product Name	M	B	W	L	A	B	C	H	Material	Weight
<b>MF S13</b>	Slot 8	Pin T-slot Nut	6	16	17	40	25	16	2.9	9.6	8.8 Steel	35.6 gr

TIMH KOMMATI  
**3,70 €**

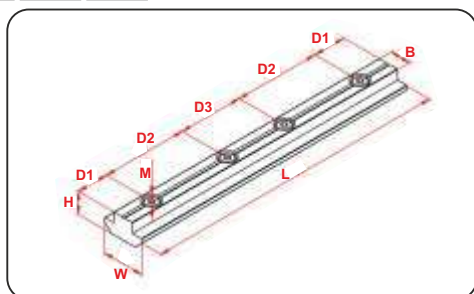

Code	Icon	Product Name	M	B	W	L	D3	D2	D1	H	Material	Weight
<b>M 107 A</b>	Slot 6	Long Nuts	M5	6	10	100	20	30	10	5	8.8 Steel	29 gr
<b>M 107 B</b>	Slot 8	Long Nuts	M6	7,8	16	120	35	35	7,5	6	8.8 Steel	77.5 gr
<b>M 107 C</b>	Slot 10	Long Nuts	M8	10	20	140	30	40	15	10,5	8.8 Steel	150 gr

TIMH KOMMATI  
**2,00 €**  
**2,80 €**  
**4,30 €**

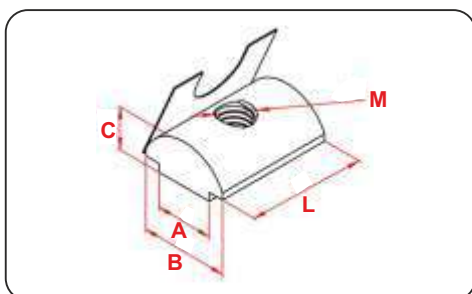

Code	Icon	Product Name	M	A	B	C	L	Material	Weight
<b>M 45/K</b>	Slot 8	Spring Slot Nut	M4	8	13	5.5	16	8.8 Steel	3.8 gr
<b>M 45/C</b>	Slot 8	Spring Slot Nut	M5	8	13	5.5	16	8.8 Steel	4 gr
<b>M 45/B</b>	Slot 8	Spring Slot Nut	M6	8	13	5.5	16	8.8 Steel	5.5 gr
<b>M 45/D</b>	Slot 8	Spring Slot Nut	M8	8	13	5.5	16	8.8 Steel	4.5 gr
<b>M 45/H</b>	Slot 10	Spring Slot Nut	M4	10	15	7.5	20	8.8 Steel	12 gr
<b>M 45/F</b>	Slot 10	Spring Slot Nut	M5	10	15	7.5	20	8.8 Steel	11.5 gr
<b>M 45/A</b>	Slot 10	Spring Slot Nut	M6	10	15	7.5	20	8.8 Steel	11.5 gr
<b>M 45</b>	Slot 10	Spring Slot Nut	M8	10	15	7.5	20	8.8 Steel	10.5 gr

TIMH KOMMATI  
**0,43 €**  
**0,43 €**  
**0,43 €**  
**0,43 €**  
**0,48 €**  
**0,48 €**  
**0,48 €**  
**0,48 €**

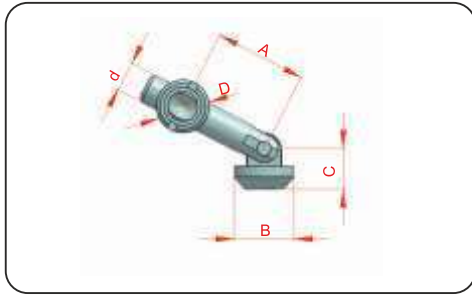
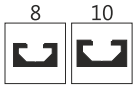

Code		Product Name	A	B	C	D	d	Material	Weight
<b>M 85/G</b>	Slot 8	Angled Puller Type Connection	12.5	15	9	12	6.8	Steel	22.5 gr
<b>M 85/C</b>	Slot 10	Angled Puller Type Connection	26	17	11.5	15	8.5	Steel	53 gr

TIMH KOMMATI  
**4,50 €**  
**5,60 €**

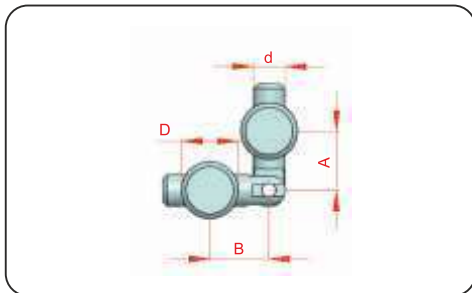
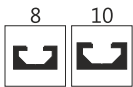

Code		Product Name	Weight	A	D	d	Material
<b>M 85/F</b>	Slot 8	Puller Type Connection With Joint	32.5 gr	12.5	12	6.8	Steel
<b>M 85/B</b>	Slot 10	Puller Type Connection With Joint	84 gr	26	15	8.5	Steel

TIMH KOMMATI  
**5,50 €**  
**6,50 €**

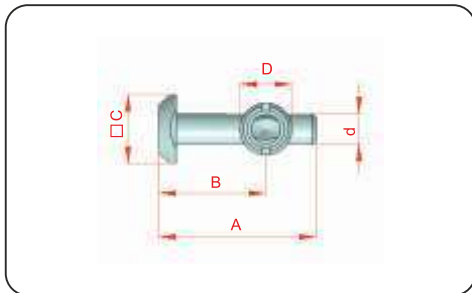
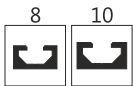

Code		Product Name	A	B	C	D	d	Material	Weight
<b>M 85/A</b>	Slot 8	Plain Puller Type Connection	29	21	16	12	6.8	Steel	24.5 gr
<b>M 85</b>	Slot 10	Plain Puller Type Connection	45.5	31	20	15	8.5	Steel	54 gr

TIMH KOMMATI  
**1,90 €**  
**2,25 €**

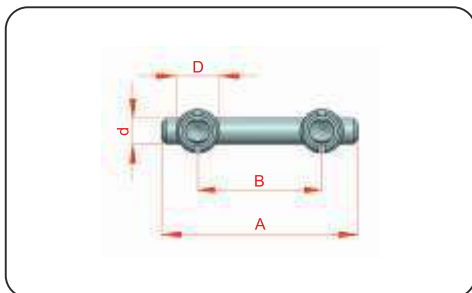
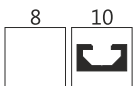

Code		Product Name	A	B	D	d	Material	Weight
<b>M 85/D</b>	Slot 10	Head Puller Type Connection	68	48	15	8.8	Steel	80.5 gr

TIMH KOMMATI  
**2,80 €**

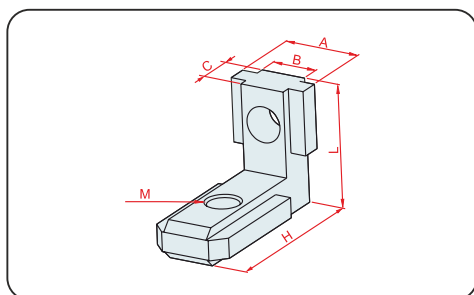

Code	Icon	Product Name	M	A	B	C	L	H	Material	Weight
<b>M 106</b>	Slot 6	Hidden Corner Connections	M5	9	6	4.8	13.5	20	Alloys	6 gr
<b>M 106 A</b>	Slot 8	Hidden Corner Connections	M6	13	8	6.7	21	30	Alloys	18.5 gr
<b>M 106 B</b>	Slot 10	Hidden Corner Connections	M8	17	10	8.4	27	40	Alloys	41 gr

TIMH KOMMATI
1,10 €
1,30 €
1,60 €

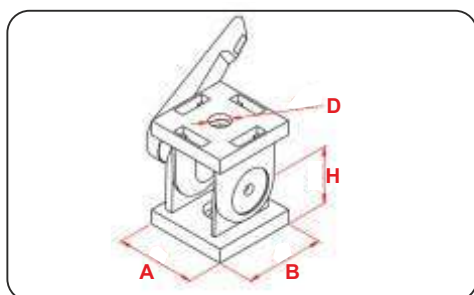

Code	Product Name	A	B	D	H	Material	Weight
<b>M 36</b>	30x30 Moving Joint	30	30	Ø8.5	22.5	Zinc	133 gr
<b>M 37/A</b>	40x40 Moving Joint	40	40	Ø8.5	30	Zinc	158 gr
<b>M 37</b>	45x45 Moving Joint	45	45	Ø10.5	30	Zinc	309 gr

TIMH KOMMATI
13,00 €
17,00 €
22,00 €

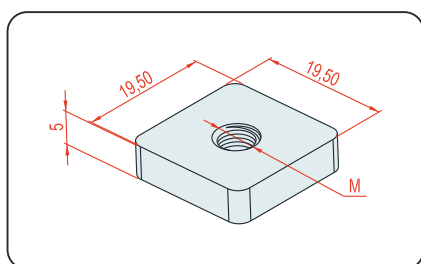

**ΔΕΝ ΜΠΑΙΝΟΥΝ ΣΕ ΟΛΑ ΤΑ ΠΡΟΦΙΛ ΣLOT 10**



Code	Icon	Product Name	M	E	Material	Weight
<b>M 46/F</b>	Slot 10	Square Nut	M4	5	Steel	13.5 gr
<b>M 46/H</b>	Slot 10	Square Nut	M5	5	Steel	13 gr
<b>M 46/E</b>	Slot 10	Square Nut	M6	5	Steel	13 gr
<b>M 46/I</b>	Slot 10	Square Nut	M8	5	Steel	12 gr
<b>M 46/D</b>	Slot 10	Square Nut	M10	5	Steel	10.5 gr

TIMH KOMMATI
0,26 €
0,26 €
0,26 €
0,26 €
0,30 €

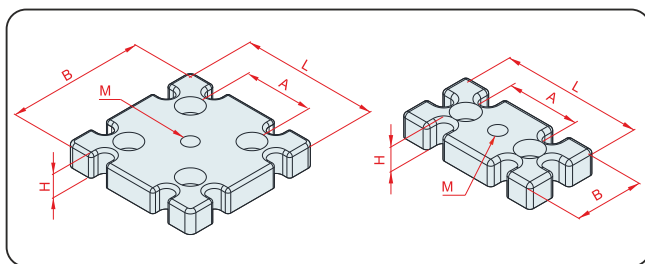
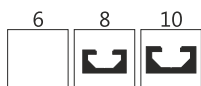

Code	Prof External	Product Name	M	A	L	B	H	Material	Weight
<b>M 81/C</b>	30x60	Levelling Feet Plate	M6	30	60	30	16	Aluminium	45 gr
<b>M 81/B</b>	40x80	Levelling Feet Plate	M10	40	80	40	15	Aluminium	76 gr
<b>M 81/A</b>	45x90	Levelling Feet Plate	M12	45	90	45	15	Aluminium	100 gr
<b>M 81/F</b>	60x60	Levelling Feet Plate	M12	30	60	60	15	Aluminium	119 gr
<b>M 81/G</b>	80x80	Levelling Feet Plate	M12	40	80	80	15	Aluminium	217.5 gr
<b>M 81</b>	90x90	Levelling Feet Plate	M16	45	90	90	15	Aluminium	195 gr

TIMH KOMMATI
3,00 €
4,00 €
5,00 €
6,00 €
7,00 €
8,00 €

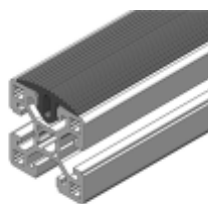
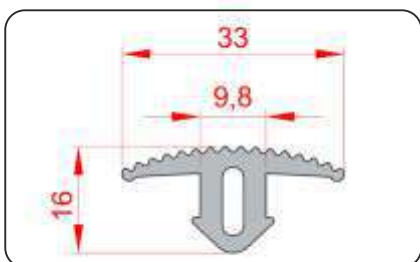

Code	Product Name	Weight
<b>PE 33</b>	Προστατευτικό ελαστικό προφίλ 40x40 - 45x45 ενιαία επιφάνεια	210 gr/m

TIMH METPO
3,50 €

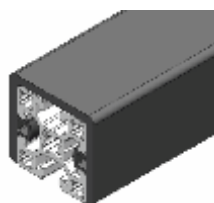
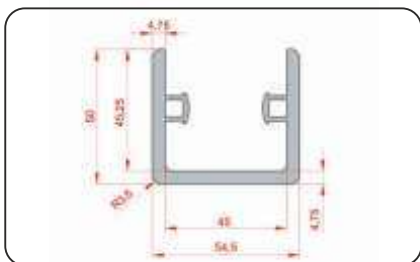

Code	Product Name
<b>PE 54</b>	Προφίλ προστατευτικού ελαστικού 45x45 Τρεις πλευρές

TIMH METPO
17,70 €

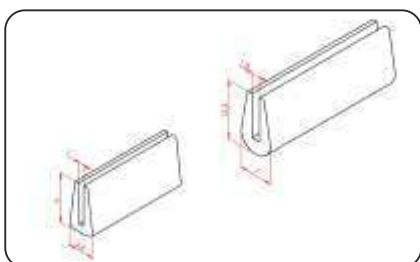

Code	Product Name	Weight
<b>SW 15</b>	Προφίλ προστατευτικού λαμαρίνας 1,00mm έως 1,50mm	38,28 gr/m
<b>SW 25</b>	Προφίλ προστατευτικού λαμαρίνας 2,00mm έως 2,50mm	76 gr/m

TIMH METPO
0,65 €
1,30 €

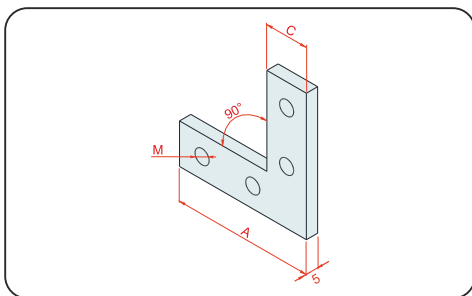

Code	Prof External	Product Name	A	C	M	Material	Weight
<b>M 034/A</b>	20x20	90° Connection Part	9.3	45	M4	Steel	17.5 gr
<b>M 032/A</b>	25x25	90° Connection Part	12.3	45	M5	Steel	30 gr
<b>M 034</b>	30x30	90° Connection Part	14	45	M6	Steel	33.5 gr
<b>M 032</b>	40x40	90° Connection Part	16.5	61.5	M8	Steel	52.3 gr
<b>M 035/T</b>	45x45	90° Connection Part	19.5	55	M8	Steel	71 gr

TIMH KOMMATI
2,00 €
2,50 €
2,50 €
3,00 €
3,20 €

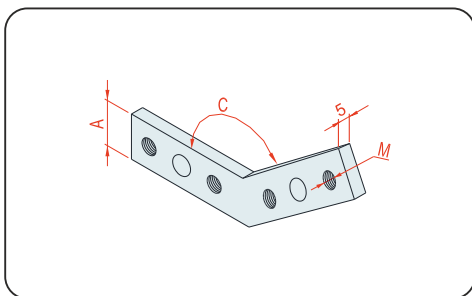

Code	Prof External	Product Name	A	C	M	Material	Weight
<b>M 35/G</b>	20x20	120° Connection Part	9.3	41	M4	Steel	17 gr
<b>M 35/E</b>	25x25	120° Connection Part	12.3	40	M5	Steel	27 gr
<b>M 35</b>	30x30	120° Connection Part	14	54	M6	Steel	43 gr
<b>M 35/X</b>	40x40	120° Connection Part	16.5	54	M8	Steel	49 gr
<b>M 33</b>	45x45	120° Connection Part	19.5	61	M8	Steel	92 gr

TIMH KOMMATI
2,00 €
2,35 €
2,60 €
2,80 €
3,40 €

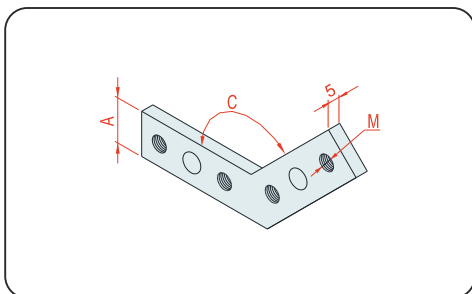

Code	Prof External	Product Name	A	C	M	Material	Weight
<b>M 34/D</b>	20x20	135° Connection Part	9.3	38.5	M4	Steel	16 gr
<b>M 32/B</b>	25x25	135° Connection Part	12.3	39.5	M5	Steel	27 gr
<b>M 35/A</b>	30x30	135° Connection Part	14	51	M6	Steel	41 gr
<b>M 33/X</b>	40x40	135° Connection Part	16.5	52	M6	Steel	48 gr
<b>M 33/A</b>	45x45	135° Connection Part	19.5	63	M8	Steel	88 gr

TIMH KOMMATI
2,00 €
2,35 €
2,85 €
3,00 €
3,45 €

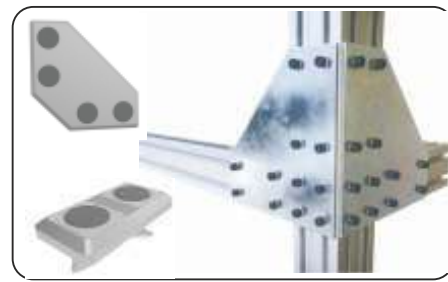
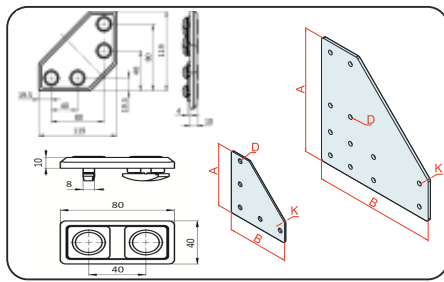

Code	Prof External	Product Name	A	B	ØD	K	Material	Weight
<b>M 051</b>	20x25	2 Way Connection Plate	75	75	5	3	Zinc	96.5 gr
<b>M 72/A</b>	30x30	2 Way Connection Plate	80	80	6.5	3	Zinc	119 gr
<b>M 56/L</b>	40x40	2 Way Connection Plate	110	110	6.5	3	Steel	218 gr
<b>M 56</b>	45x45	2 Way Connection Plate	120	120	8.5	3	Steel	256 gr
<b>M 76</b>	45x90	2 Way Connection Plate	180	180	8.5	4	Steel	850 gr
<b>M 76/L</b>	80x80	2 Way Connection Plate	200	200	6.5	4	Steel	990 gr
<b>M 66</b>	90x90	2 Way Connection Plate	240	240	8.5	5	Steel	1.782 gr

TIMH KOMMATI
2,50 €
2,70 €
3,50 €
4,00 €
8,50 €
9,50 €
13,50 €

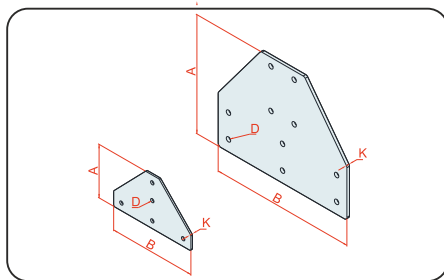

Code	Prof External	Product Name	A	B	ØD	K	Material	Weight
<b>M 051/A</b>	20x25	3 Way Connection Plate	75	86	5	3	Zinc	109.5 gr
<b>M 72/B</b>	30x30	3 Way Connection Plate	90	150	6.5	3	Steel	221.5 gr
<b>M 72/L</b>	40x40	3 Way Connection Plate	110	150	6.5	3	Steel	280 gr
<b>M 56/A</b>	45x45	3 Way Connection Plate	120	160	8.5	3	Steel	322 gr
<b>M 76/A</b>	45x90	3 Way Connection Plate	170	130	8.5	4	Steel	622 gr
<b>M 66/L</b>	80x80	3 Way Connection Plate	160	220	6.5	4	Steel	900 gr
<b>M 66/A</b>	90x90	3 Way Connection Plate	200	250	8.5	5	Steel	1.581 gr

TIMH KOMMATI
3,00 €
3,90 €
4,30 €
4,70 €
6,60 €
8,50 €
13,20 €

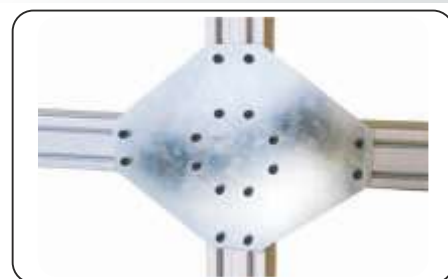
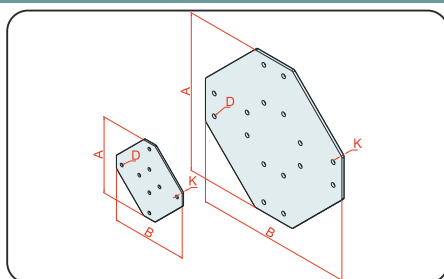

Code	Prof External	Product Name	A	B	ØD	K	Material	Weight
<b>M 051/B</b>	20x25	4 Way Connection Plate	130	130	5	3	Zinc	248 gr
<b>M 72/C</b>	30x30	4 Way Connection Plate	150	150	6.5	3	Steel	334 gr
<b>M 72/J</b>	40x40	4 Way Connection Plate	150	150	6.5	4	Steel	370 gr
<b>M 56/B</b>	45x45	4 Way Connection Plate	180	180	8.5	4	Steel	689 gr
<b>M 66/J</b>	80x80	4 Way Connection Plate	200	200	6.5	4	Steel	1180 gr
<b>M 66/B</b>	90x90	4 Way Connection Plate	311	311	8.5	5	Steel	2.739 gr

TIMH KOMMATI
3,20 €
4,00 €
4,50 €
6,00 €
10,20 €
19,60 €



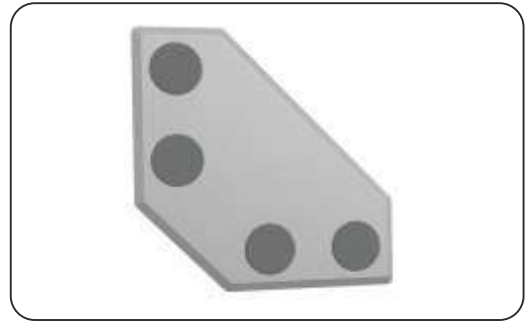
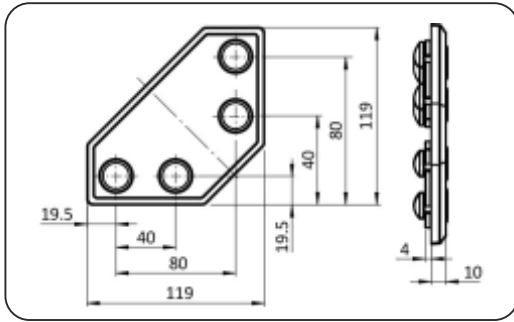

Code	Prof External	Product Name	A	B	ØD	K	Material	Weight
<b>MF 120</b>	80x40	2 Way Connection Plate	119	99.5	8	4	Steel	331.6 gr

TIMH KOMMATI  
**14,50 €**

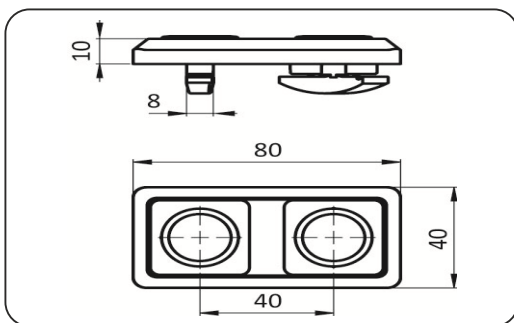

Code	Prof External	Product Name	A	B	ØD	K	Material	Weight
<b>M 72/A</b>	80x40	2 Way Connection Plate	80	40	8	10	Steel	111.1 gr

TIMH KOMMATI  
**7,90 €**





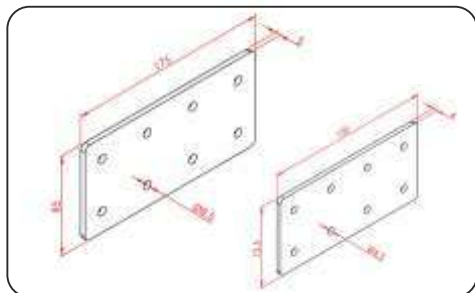
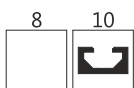

Code	Product Name	A	C	ØD	L	Material	Weight
<b>M 148</b>	40x80 Plain Additional Connection Plate	72.5	4	6.5	150	HRP	330 gr
<b>M 148/J</b>	45x90 Plain Additional Connection Plate	85	5	8.5	175	HRP	564 gr

TIMH KOMMATI  
**5,50 €**  
**6,50 €**

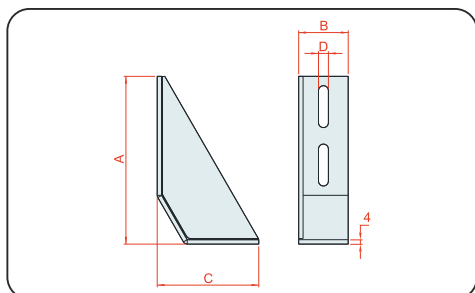
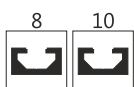

Code	Product Name	A	B	C	D	Material	Weight
<b>M 57</b>	Foot Fixing Bracket	153	45	92	9	Steel	488.5 gr

TIMH KOMMATI  
**8,00 €**

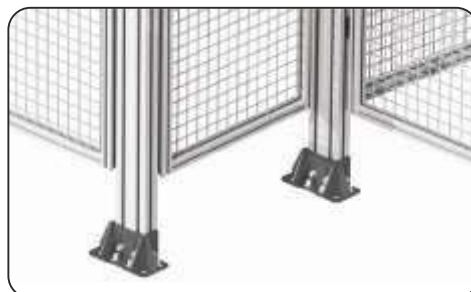
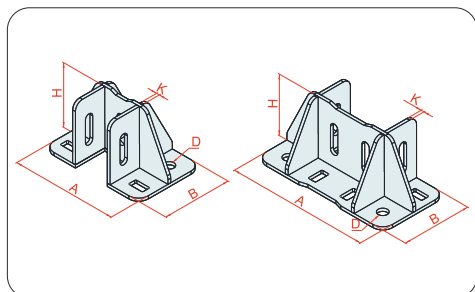
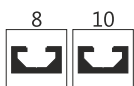

Code	Prof External	Product Name	A	B	D	H	K	Material	Weight
<b>M 152</b>	45x45	Based Foot Connection Elements	135	89	13	80	4	Steel	862 gr
<b>M 153</b>	45x90	Based Foot Connection Elements	180	89	13	80	4	Steel	972 gr
<b>M 154</b>	40x40	Based Foot Connection Elements	130	89	13	66	4	Steel	740 gr
<b>M 155</b>	40x80	Based Foot Connection Elements	170	89	13	66	4	Steel	860 gr

TIMH KOMMATI  
**13,00 €**  
**14,00 €**  
**12,00 €**  
**13,00 €**

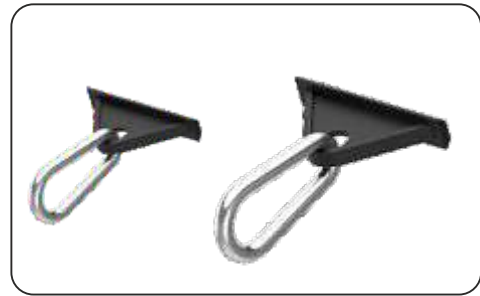
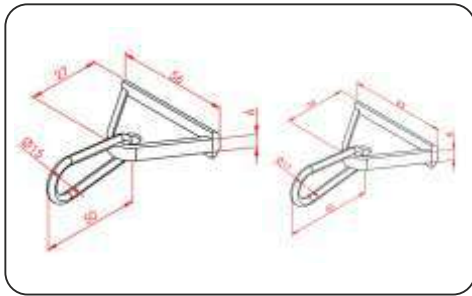
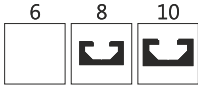

Code	Product Name	Material	Weight
<b>M 72/20</b>	Hanger 20.25	Plastic+ Steel	18 gr
<b>M 73</b>	Hanger 30.45	Plastic+ Steel	36 gr

TIMH KOMMATI

**2,00 €**

**2,30 €**

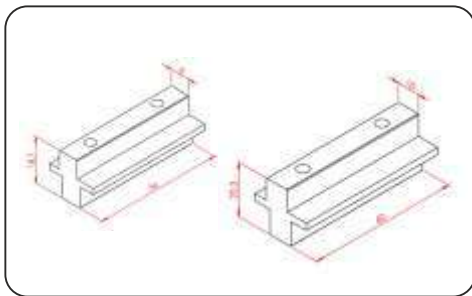

Code	Slot	Product Name	A	C	H	L	M	Material	Weight
<b>M 75/B</b>	Slot 8	Slide Rail	8	2	18.7	53	M4	Derlin	8.5 gr
<b>M 75/A</b>	Slot 10	Slide Rail	10	2.5	20.3	60	M4	Derlin	13 gr

TIMH KOMMATI

**1,80 €**

**2,30 €**

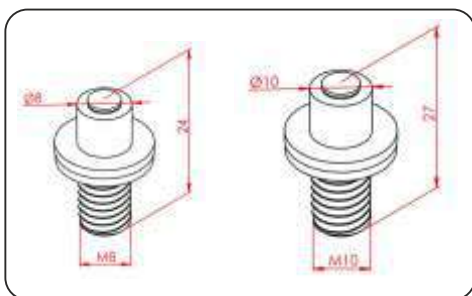

Code	Slot	Product Name	A	C	H	L	M	Material	Weight
<b>M 75/D</b>	Slot 8	Accordion Slide Pin	8	15	3	24	M8	Steel+Derlin	7 gr
<b>M 75/C</b>	Slot 10	Accordion Slide Pin	10	18	3	27	M10	Steel+Derlin	12.5 gr

TIMH KOMMATI

**3,00 €**

**3,60 €**



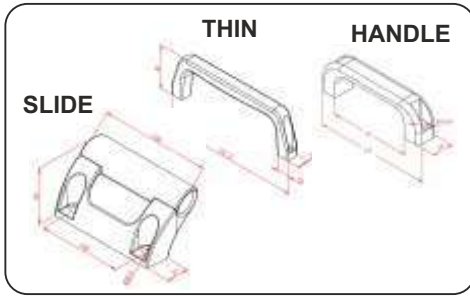
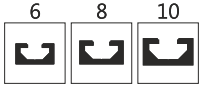

Code	Product Name	H	L	L1	B	D	Material	Weight
<b>M 67</b>	Plastic Handle	40.5	131.5	91.5	25	Ø8.4	Plastic	44.5 gr
<b>M 68</b>	Plastic Handle Thin	40.5	130	104	12	Ø5	Plastic	25 gr
<b>M 69</b>	Plastic Slide-in Handle	6	134	100	27	Ø8.5	Plastic	110 gr

TIMH KOMMATI
1,40 €
1,50 €
14,50 €

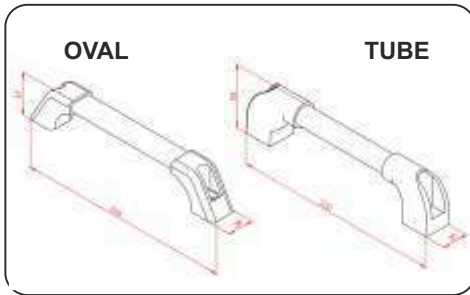

Code	Product Name	H	L	L1	B	D	Material	Weight
<b>M 67 AO</b>	Aluminium Tube Handle Oval	47	233	-	38	-	Aluminium & PVC	88 gr
<b>M 68 AO</b>	Aluminium Tube Handle Oval	43	230	-	34	-	Aluminium & PVC	70 gr
<b>M 69 AT</b>	Aluminium Tube Handle	56	232	-	30	-	Aluminium & PVC	81 gr
<b>M 78</b>	Aluminium Tube Handle	68	236	-	36	-	Aluminium & PVC	103 gr

TIMH KOMMATI
4,50 €
3,70 €
3,80 €
4,20 €

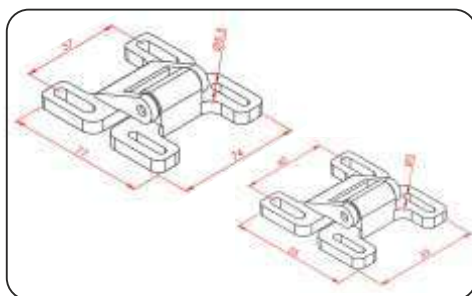

Code	Product Name	Prof External	L	L1	B	D	Material	Weight
<b>M 69/C</b>	Ball Catch	20 - 25 - 30	53	40	55	Ø5	Plastic	25 gr
<b>M 69/F</b>	Ball Catch	35 - 40 - 45	74	57	77	Ø5.5	Plastic	40 gr

TIMH KOMMATI
3,10 €
3,80 €

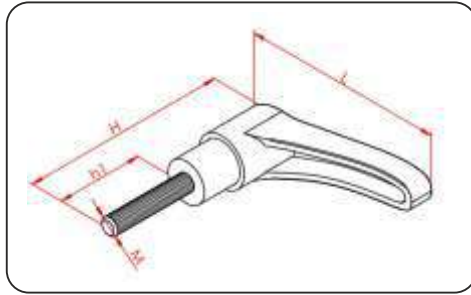

Code	Product Name	M	H	h1	L	Material	Weight
<b>M 73/A</b>	Adjustable Handle	M6	72	30	78	Plastic	41 gr
<b>M 73/B</b>	Adjustable Handle	M8	92	50	78	Plastic	52 gr
<b>M 73/C</b>	Adjustable Handle	M10	102	60	78	Plastic	65 gr

TIMH KOMMATI
<b>2,70 €</b>
<b>3,10 €</b>
<b>3,40 €</b>

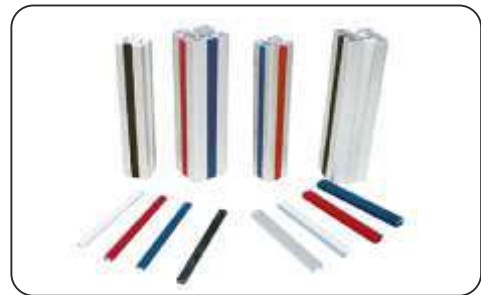
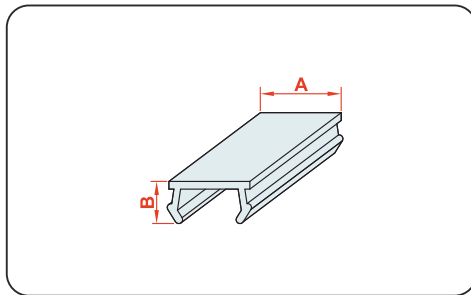

Code	Icon	Product Name	Colour	A	B	Material	Weight
<b>M 79</b>	Slot 6	Slot Seal	● ● ● ●	7.3	3.8	PVC	15,60 gr
<b>M 49</b>	Slot 8	Slot Seal	● ● ● ●	8.9	4.3	PVC	18,30 gr
<b>M 59</b>	Slot 10	Slot Seal	● ● ● ●	11.7	8.1	PVC	45,00 gr

TIMH/m KOMMATI
<b>0,50 €</b>
<b>0,65 €</b>
<b>0,75 €</b>

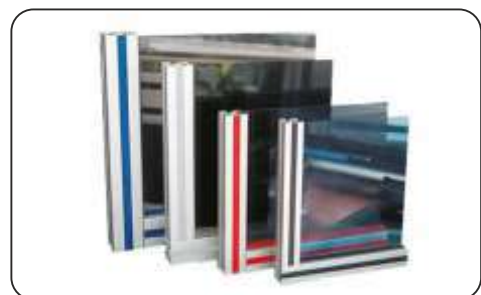
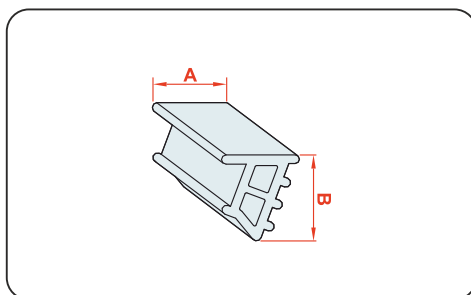

Code	Icon	Product Name	Colour	A	B	Material	Weight
<b>M 70</b>	Slot 6	Glass Seal	● ●	7	7	PVC	41,00 gr
<b>M 72</b>	Slot 8	Glass Seal	● ● ●	8.5	11.3	PVC	80,00 gr
<b>M 71</b>	Slot 10	Glass Seal	● ● ●	11	12.1	PVC	82,00 gr

TIMH/m KOMMATI
<b>0,55 €</b>
<b>1,00 €</b>
<b>1,10 €</b>

### Πόμολα μαργαρίτα με αρσενικό πάσο

Βακελίτης με αντοχή σε διαλύτες, λάδια, γράσα και χημικά PF. 7 λοβοί.

Κωδικός	Τύπος	Πάσο	Τιμή	Κωδικός	Τύπος	Πάσο	Τιμή
B1V7M300620	30mm	M6X20mm	1,68€	B1V7M401040	40mm	M10X40mm	2,00€
B1V7M300630	30mm	M6X30mm	1,70€	B1V7M500820	50mm	M8X20mm	2,64€
B1V7M300815	30mm	M8X15mm	1,68€	B1V7M500830	50mm	M8X30mm	2,65€
B1V7M300825	30mm	M8X25mm	1,70€	B1V7M500840	50mm	M8X40mm	2,66€
B1V7M400630	40mm	M6X30mm	1,70€	B1V7M501240	50mm	M12X40mm	2,90€
B1V7M400640	40mm	M6X40mm	1,75€	B1V7M501040	50mm	M10X40mm	2,85€
B1V7M400820	40mm	M8X20mm	1,80€	B1V7M600840	60mm	M8X40mm	3,61€
B1V7M400830	40mm	M8X30mm	1,85€	B1V7M601030	60mm	M10X30mm	3,73€
B1V7M400840	40mm	M8X40mm	1,87€	B1V7M601050	60mm	M10X50mm	3,86€
B1V7M400850	40mm	M8X50mm	1,93€	B1V7M601240	60mm	M12X40mm	3,89€
B1V7M401030	40mm	M10X30mm	1,93€	B1V7M601250	60mm	M12X50mm	4,00€



Ιταλίας

### Πόμολα μαργαρίτα με αρσ. πάσο INOX AISI 304

Βακελίτης με αντοχή σε διαλύτες, λάδια, γράσα και χημικά PF. 7 λοβοί.

Κωδικός	Τύπος	Πάσο	Τιμή
B1V7MX300430	30mm	M4X30mm	3,26€
B1V7MX300620	30mm	M6X20mm	3,37€
B1V7MX400630	40mm	M6X30mm	3,50€
B1V7MX401030	40mm	M10X30mm	3,96€
B1V7MX501040	50mm	M10X40mm	5,47€



Ιταλίας

### Πόμολα μαργαρίτα από PF Duroplast με αρσενικό πάσο

Ανθεκτικά σε έλαια, λίπη, καύσιμα και διαλύτες. 6 λοβοί.



Κωδικός	Τύπος	Πάσο	Τιμή
01PF2B20	PF2 M5X20	20mm M5X20mm	2,24€
01PF2B30	PF2 M5X30	20mm M5X30mm	2,30€
01PF3P25	PF3 M8X25	30mm M8X25mm	2,42€
01PF4C25	PF4 M6X25	40mm M6X25mm	2,60€
01PF4C40	PF4 M6X40	40mm M6X40mm	2,78€
01PF4D20	PF4 M8X20	40mm M8X20mm	2,80€
01PF4D40	PF4 M8X40	40mm M8X40mm	2,92€
01PF6F45	PF6 M12X45	45mm M12X45mm	5,34€
01PF5D20	PF4 M8X20	50mm M8X20mm	3,28€
01PF5D35	PF5 M8X35	50mm M8X35mm	3,44€
01PF6E50	PF6 M10X50	50mm M10X40mm	5,12€
01PF6D25	PF6 M8X25	60mm M8X25mm	4,76€
01PF6D40	PF6 M8X40	60mm M8X40mm	4,94€
01PF6E30	PF6 M10X30	60mm M10X30mm	5,06€
01PF6E70	PF6 M10X70	60mm M10X70mm	5,34€



Ιταλίας

### Πόμολα μαργαρίτα από PF Duroplast με αρσενικό πάσο INOX

Ανθεκτικά σε έλαια, λίπη, καύσιμα και διαλύτες. 6 λοβοί.



Κωδικός	Τύπος	Πάσο	Τιμή
01PF2B20X	PF2 M5X20	20mm M5X20mm	3,46€
01PF2B30X	PF2 M5X30	20mm M5X30mm	3,70€
01PF2B40X	PF2 M5X40	20mm M5X40mm	4,24€
01PF2C20X	PF2 M6X20	20mm M6X20mm	3,30€
01PF2C30X	PF2 M6X30	20mm M6X30mm	3,84€
01PF2C40X	PF2 M6X40	20mm M6X40mm	4,80€
01PF3D15X	PF3 M8X15	30mm M8X15mm	5,04€
01PF3D25X	PF3 M8X25	30mm M8X25mm	5,54€
01PF4C25X	PF4 M6X25	40mm M6X25mm	4,90€



Ιταλίας

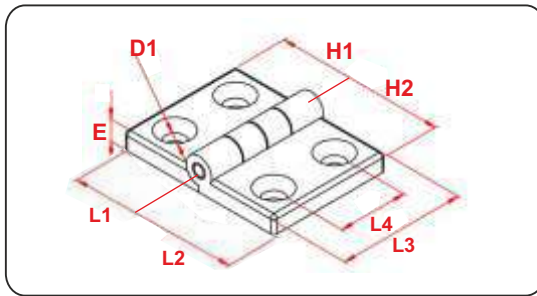

Code	Prof External	Product Name	E	H1	H2	L1	L2	L3	L4	D1	Material	Weight
<b>M 65/K</b>	20x20	Hinge (Thin Series)	5	10.25	10.25	18.35	18.35	35	19	6	PA6 Black	8.5 gr
<b>M 65/G</b>	25x25	Hinge (Thin Series)	5	12.75	12.75	23.35	23.35	35	19	6	Pa6 Black	11 gr
<b>M 65/H</b>	20x25	Hinge (Thin Series)	5	10.25	15.25	18.35	23.35	35	19	6	Pa6 Black	10 gr
<b>M 65/A</b>	30x30	Hinge	8	15	15	25	25	50	30	6.5	Pa6 Black	29.5 gr
<b>M 65/B</b>	35x35	Hinge	8	17.5	17.5	32	32	50	30	6.5	Pa6 Black	34 gr
<b>M 65/D</b>	45x30	Hinge	8	22.75	15	32	25	50	30	6.5	Pa6 Black	31 gr
<b>M 65/J</b>	35x45	Hinge	8	22.75	17.5	32	32	50	30	6.5	Pa6 Black	33 gr
<b>M 65/C</b>	45x45	Hinge	8	22.75	22.75	32	32	50	30	6.5	Pa6 Black	34 gr

TIMH KOMMATI
1,30 €
1,40 €
1,40 €
1,50 €
1,55 €
1,65 €
1,70 €
1,70 €

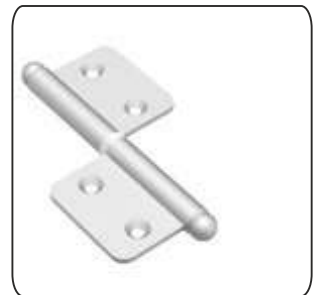
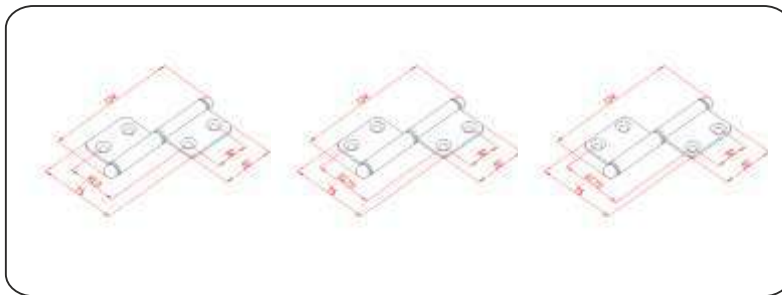

Code	Prof External	Product Name	Material	Weight
<b>ML 30</b>	30x30	30x30 Leaf Hinge	Aluminium	8.5 gr
<b>ML 40</b>	40x40	40x40 Leaf Hinge	Aluminium	11 gr
<b>ML 45</b>	45x45	45x45 Leaf Hinge	Aluminium	9.5 gr

TIMH KOMMATI
2,80 €
2,80 €
2,80 €

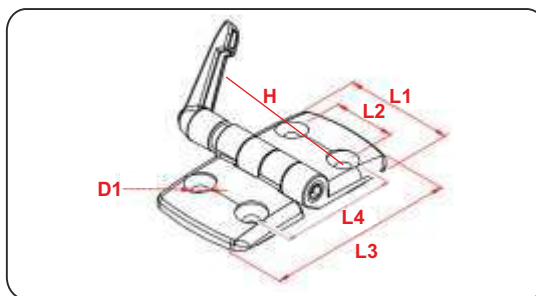

Code	Prof External	Product Name	H	L1	L2	L3	L4	D1	Material	Weight
<b>M 92/A</b>	25x25	Hinges With Lock	72	48	28	52	30	6,6	Pa6 Black	46 gr
<b>M 92/B</b>	30x30	Hinges With Lock	72	48	28	59	35	6,9	Pa6 Black	48 gr
<b>M 92/C</b>	45x45	Hinges With Lock	72	48	28	87	50	6,6	Pa6 Black	60,5 gr
<b>M 92/D</b>	45x45	Hinge Cover	62,2	56	36	73	45,5	6,6	Pa6 Black	41 gr

TIMH KOMMATI
11,80 €
11,80 €
15,50 €
8,80 €

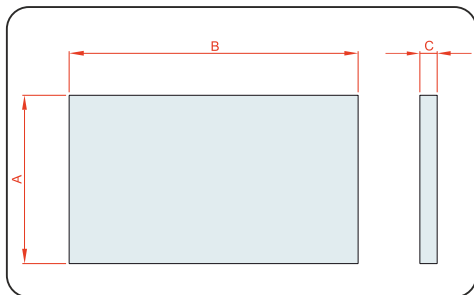

Code	Product Name	A	B	C	Material	Weight
<b>PX 30</b>	Plexiglass 3 mm	2050	3050	3	Plexiglass	3,57 kg/m <sup>2</sup>
<b>PX 40</b>	Plexiglass 4 mm	2050	3050	4	Plexiglass	4,76 kg/m <sup>2</sup>
<b>PX 50</b>	Plexiglass 5 mm	2050	3050	5	Plexiglass	5,95 kg/m <sup>2</sup>
<b>PX 60</b>	Plexiglass 6 mm	2050	3050	6	Plexiglass	7,14 kg/m <sup>2</sup>
<b>PX 80</b>	Plexiglass 8 mm	2050	3050	8	Plexiglass	9,52 kg/m <sup>2</sup>
<b>PX 100</b>	Plexiglass 10 mm	2050	3050	10	Plexiglass	11,90 kg/m <sup>2</sup>

ΜΠΟΡΟΥΝ ΝΑ ΚΟΠΟΥΝ  
ΣΤΙΣ ΕΠΙΘΥΜΗΤΕΣ  
ΔΙΑΣΤΑΣΕΙΣ

ΔΙΑΤΙΘΟΝΤΑΙ ΣΕ  
ΔΙΑΦΟΡΑ ΧΡΩΜΑΤΑ

ΤΙΜΗ ΚΑΤΟΠΙΝ  
ΣΥΝΝΕΝΟΗΣΗΣ

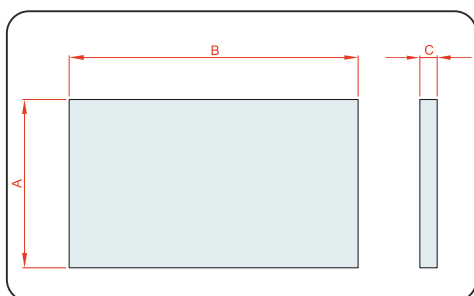

Code	Product Name	A	B	C	Material	Weight
<b>PC 40</b>	Πολυκαρβονικό 4 mm	2100	6000	4	Πολυκαρβονικό	0,80 kg/m <sup>2</sup>
<b>PC 60</b>	Πολυκαρβονικό 6 mm	2100	6000	6	Πολυκαρβονικό	1,30 kg/m <sup>2</sup>
<b>PC 80</b>	Πολυκαρβονικό 8 mm	2100	6000	8	Πολυκαρβονικό	1,50 kg/m <sup>2</sup>
<b>PC 100</b>	Πολυκαρβονικό 10 mm	2100	6000	10	Πολυκαρβονικό	1,70 kg/m <sup>2</sup>
<b>PC 160</b>	Πολυκαρβονικό 16 mm	2100	6000	16	Πολυκαρβονικό	2,55 kg/m <sup>2</sup>
<b>PC 200</b>	Πολυκαρβονικό 20 mm	2100	6000	20	Πολυκαρβονικό	3,10 kg/m <sup>2</sup>

ΜΠΟΡΟΥΝ ΝΑ ΚΟΠΟΥΝ  
ΣΤΙΣ ΕΠΙΘΥΜΗΤΕΣ  
ΔΙΑΣΤΑΣΕΙΣ

ΔΙΑΤΙΘΟΝΤΑΙ ΣΕ  
ΔΙΑΦΟΡΑ ΧΡΩΜΑΤΑ

ΤΙΜΗ ΚΑΤΟΠΙΝ  
ΣΥΝΝΕΝΟΗΣΗΣ

Code	Product Name	A	B	C	Material	Weight
<b>PCB 30</b>	Συμπ. Πολυκαρβονικό 3 mm	2050	3050 6100	3	Πολυκαρβονικό	3,60 kg/m <sup>2</sup>
<b>PCB 40</b>	Συμπ. Πολυκαρβονικό 4 mm	2050	3050 6100	4	Πολυκαρβονικό	4,80 kg/m <sup>2</sup>
<b>PCB 50</b>	Συμπ. Πολυκαρβονικό 5 mm	2050	3050 6100	5	Πολυκαρβονικό	6,00 kg/m <sup>2</sup>
<b>PCB 60</b>	Συμπ. Πολυκαρβονικό 6 mm	2050	3050 6100	6	Πολυκαρβονικό	7,20 kg/m <sup>2</sup>
<b>PCB 80</b>	Συμπ. Πολυκαρβονικό 8 mm	2050	6100	8	Πολυκαρβονικό	9,60 kg/m <sup>2</sup>
<b>PCB 100</b>	Συμπ. Πολυκαρβονικό 10 mm	2050	6100	10	Πολυκαρβονικό	12,00 kg/m <sup>2</sup>

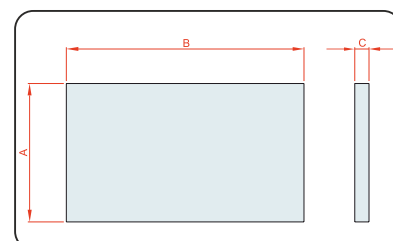

ΜΠΟΡΟΥΝ ΝΑ ΚΟΠΟΥΝ  
ΣΤΙΣ ΕΠΙΘΥΜΗΤΕΣ  
ΔΙΑΣΤΑΣΕΙΣ

ΔΙΑΤΙΘΟΝΤΑΙ ΣΕ  
ΔΙΑΦΟΡΑ ΧΡΩΜΑΤΑ

ΤΙΜΗ ΚΑΤΟΠΙΝ  
ΣΥΝΝΕΝΟΗΣΗΣ



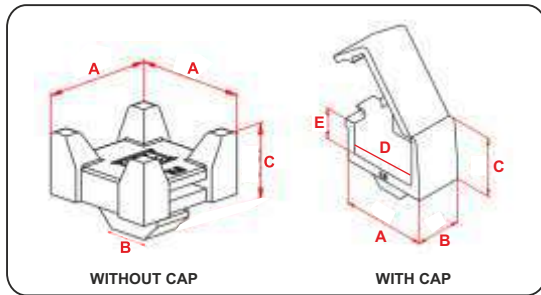
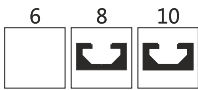

Code	Product Name	A	B	C	D	E	Material	Weight
<b>M 82</b>	Cable Holder Without Cap S10	22	10	22.3	-	-	Plastic	4.24 gr
<b>M 82/8</b>	Cable Holder Without Cap S8	22	8	17.2	-	-	Plastic	3.55 gr
<b>M 83</b>	Cable Holder With Cap S10	34	16	20	30	10	Plastic	5.74 gr
<b>M 83/8</b>	Cable Holder With Cap S8	28	15	20	24	10	Plastic	4.86 gr

TIMH KOMMATI

**1,30 €**

**1,30 €**

**1,30 €**

**1,30 €**

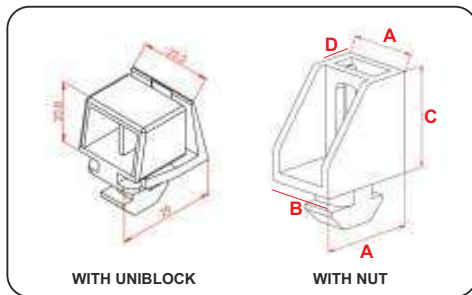

Code	Product Name	A	B	C	D	Material	Weight
<b>M 109</b>	Plexi Holder With Nut S10	25	18	25	5,5	Plastic	5.74 gr
<b>M 109/S8</b>	Plexi Holder With Nut S8	23,5	18	25	5,5	Plastic	4.86 gr
<b>M 109/A</b>	Plexi Holder With Uniblock	20,8	29	22,2	-	Plastic	7,46 gr

TIMH KOMMATI

**1,40 €**

**1,30 €**

**1,80 €**

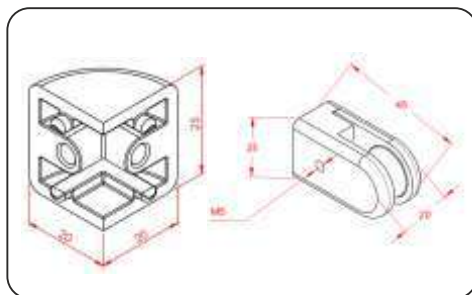

Code	Product Name	A	B	C	D	R	Material	Weight
<b>M 120</b>	Plexi Holder Metal Single	20	32,5	25	Ø4,2	12,5	Aluminium	25 gr
<b>M 120/A</b>	Metal Plexi Holder Dual	20	8	65	65	-	Aluminium	82 gr

TIMH KOMMATI

**12,00 €**

**22,00 €**

### Slot Sliding Wheel

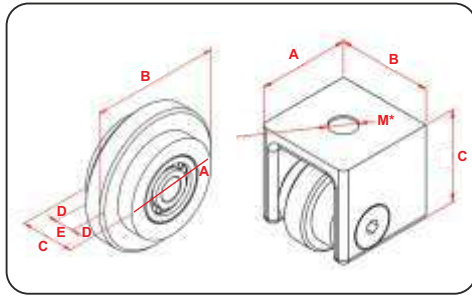

Code		Product Name	A	B	C	D	E	Material	Weight
<b>M 88/B</b>	Slot 8	Slot Sliding Wheel	33.5	47	19.3	5.8	7.8	Black Polyethylene	47 gr
<b>M 88/A</b>	Slot 10	Slot Sliding Wheel	68.5	48	29	9.5	9.5	Black Polyethylene	90 gr
<b>M 88/X</b>	Slot 10	Sliding Wheel set 40x40	40	40	40			Aluminium	116 gr
<b>M 88/Y</b>	Slot 10	Sliding Wheel set 45x45	45	45	45			Aluminium	170 gr
<b>M 88/J</b>	Slot 10	Sliding Wheel set 30x30	30	30	30			Aluminium	80 gr

**TIMH KOMMATI**

**8,00 €**

**11,50 €**

**16,00 €**

**17,50 €**

**11,00 €**

### Safety Lock

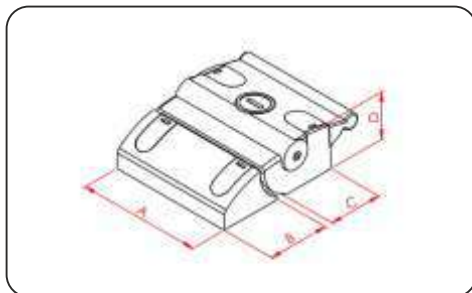

Code	Product Name	A	B	C	D	Material	Weight
<b>M 92</b>	Safety Lock	80	40	35	31	Aluminium	243 gr

**TIMH KOMMATI**

**27,00 €**

### Safety Fence Connector

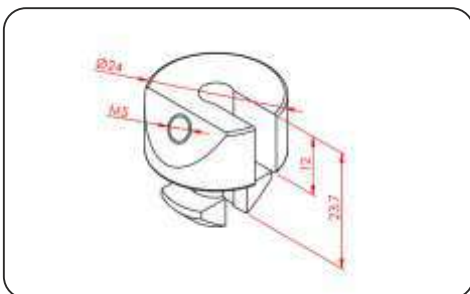

Code	Product Name	A	B	C	D	d1	M	Material	Weight
<b>M 77</b>	Safety fence Connection Part	5	12	6	24	5	M5	Aluminium	13.5 gr

**TIMH KOMMATI**

**7,10 €**

Parallel Profile Connection Kit

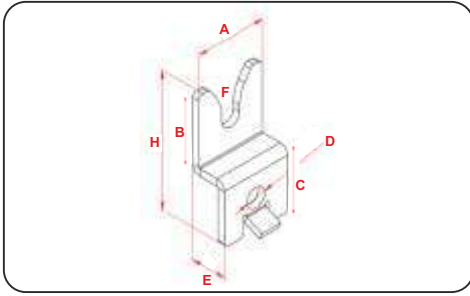

Code	Product Name	A	B	C	ØD	E	F	H	Material	Weight
<b>M 135</b>	Parallel Profile Connection Kit	30	30	27	8,5	15	8,5	57	Steel	38.5 gr

TIMH  
KOMMATI  
**2,00 €**

Wire Mesh Clamp

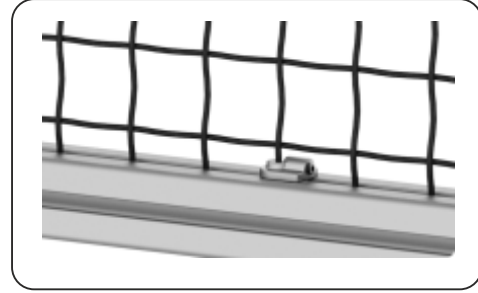
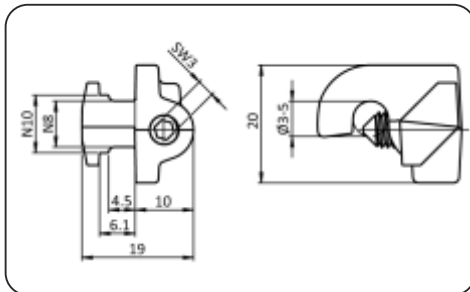

Code		Product Name	A	B	Clamping Range	Material	Weight
<b>MF 81/C</b>	8,10	Wire Mesh Clamp	20	10	3-5 mm	Zinc	20 gr

TIMH  
KOMMATI  
**2,00 €**

Wire Mesh Clamp Plate

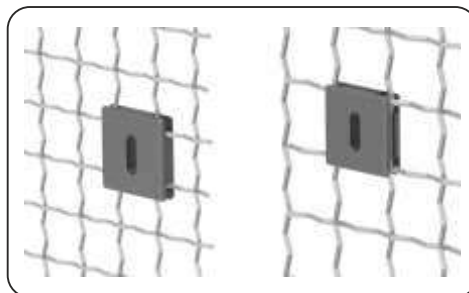
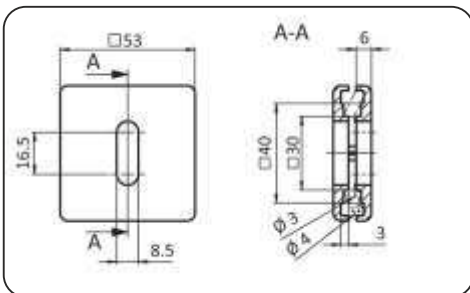

Code		Product Name	A	B	Clamping Range	Material	Weight
<b>MF 810</b>		Wire Mesh Clamp	4.5	6.1	3-5 mm	Zinc	14 gr

TIMH  
KOMMATI  
**1,70 €**

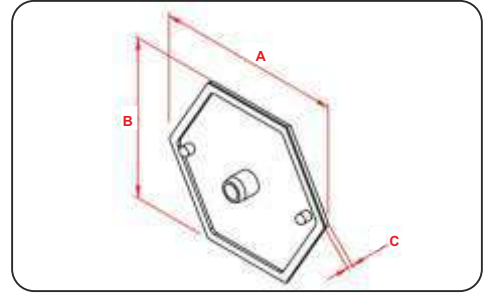
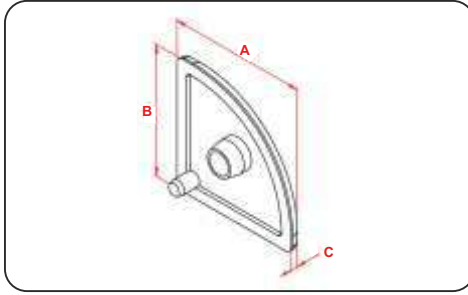
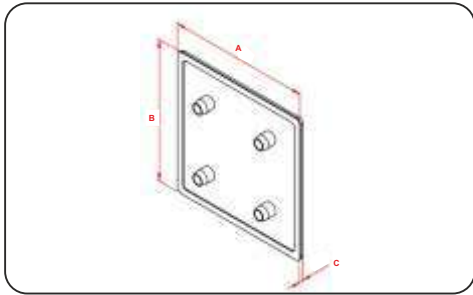
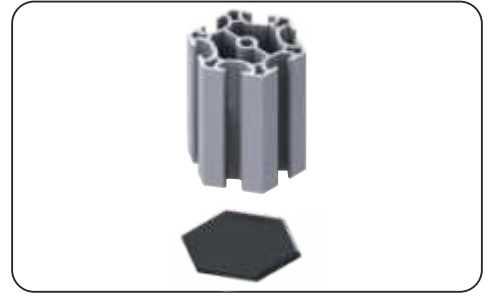
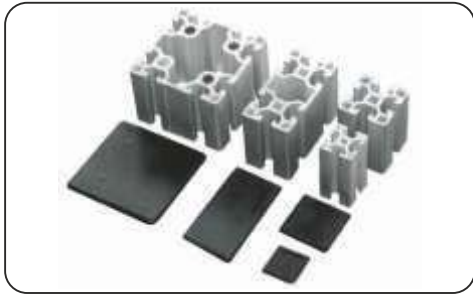

Code	Product Name	A	B	C	Color	Material	Weight	TIMH KOMMATI
M 58/P	20x20 Profile Cover	20	20	2	●	Plastic	1 gr	0,25 €
M 58/B	20x40 Profile Cover	20	40	3	●	Plastic	2 gr	0,40 €
M 58/F	20x80 Profile Cover	20	80	3	●	Plastic	4 gr	0,50 €
M 58/R	25x25 Profile Cover	25	25	3	●	Plastic	1.5 gr	0,30 €
M 58/A	30x30 Profile Cover	30	30	3	●	Plastic	3.5 gr	0,35 €
M 58/H	35x35 Profile Cover	35	35	3.3	●	Plastic	4.5 gr	0,40 €
M 58/HV	35x35 Profile Cover (S10)	35	35	3.3	●	Plastic	4 gr	0,40 €
M 170	30x60 Profile Cover	30	60	3	●	Plastic	7 gr	0,45 €
M 171	30x90 Profile Cover	30	90	3.3	●	Plastic	7.5 gr	0,55 €
M PK 40	40x40 Profile Cover (S10)	40	40	3.3	●	Plastic	5.5 gr	0,50 €
M 172	40x40 Profile Cover (S8)	40	40	3.3	●	Plastic	5.5 gr	0,50 €
M 173	40x80 Profile Cover (S8)	40	80	3.3	●	Plastic	8.88 gr	0,60 €
M PK 48	40x80 Profile Cover (S10)	40	80	3.3	●	Plastic	9.5 gr	0,60 €
M 58/C	45x45 Profile Cover	45	45	3.6	●	Plastic	8 gr	0,55 €
M 58/J	45x60 Profile Cover	45	60	3.6	●	Plastic	9.5 gr	0,60 €
M 58/D	45x90 Profile Cover	45	90	3.6	●	Plastic	15.5 gr	0,75 €
M 174	45x135 Profile Cover	45	135	3.6	●	Plastic	19 gr	1,00 €
M 175	50x50 Profile Cover	50	50	3.6	●	Plastic	8 gr	0,85 €
M 176	50x100 Profile Cover	50	100	3.6	●	Plastic	17 gr	0,90 €
M 58/G	60x60 Profile Cover	60	60	3.6	●	Plastic	11.5 gr	0,80 €
M 177	60x60 Profile Cover (S8)	60	60	3.6	●	Plastic	12.5 gr	0,85 €
M 177/G	60x90 Profile Cover	90	60	3.6	●	Plastic	18.33 gr	0,90 €
M PK 80/8	80x80 Profile Cover (S8)	80	80	3.6	●	Plastic	21.6 gr	1,00 €
M PK 80	80x80 Profile Cover	80	80	3.6	●	Plastic	19.5 gr	0,90 €
M 58/E	90x90 Profile Cover	90	90	3.6	●	Plastic	31 gr	1,00 €
M 178	20x20 Radius Profile Cover	20	20	3	●	Plastic	1 gr	0,45 €
M 58/L	30x30 Radius Profile Cover	30	30	3	●	Plastic	2.5 gr	0,55 €
M 58/M	45x45 Radius Profile Cover	45	45	3	●	Plastic	7 gr	0,75 €
M 179	23x127 Profile Cover	23	126.8	4.2	●	Plastic	18.5 gr	8,90 €
M 179/X	Hexagon Stand Profile	60	52	3	●	Plastic	5.67 gr	0,40 €

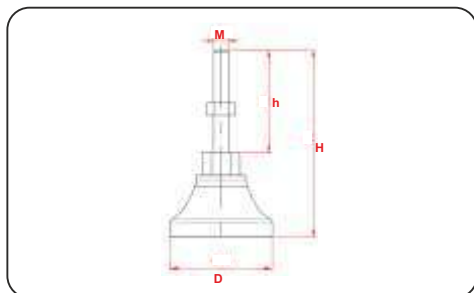

Code	Product Name	D	M	H	h	Material	Weight	Load Capacity
<b>M 62/D</b>	M6 Plastic Levelling Foot	Ø 50	M6	80	50	Plastic	41 gr	39 kg
<b>M 62</b>	M8 Plastic Levelling Foot	Ø 50	M8	80	50	Plastic	47 gr	49.5 kg
<b>M 61</b>	M10 Plastic Levelling Foot	Ø 60	M10	100	60	Plastic	111 gr	114 kg
<b>M 61/C</b>	M12 Plastic Levelling Foot	Ø 60	M12	82	50	Plastic	101 gr	152kg
<b>M 61/B</b>	M16 Plastic Levelling Foot	Ø 108	M16	145	100	Plastic	283 gr	325.5 kg

TIMH KOMMATI
2,10 €
2,20 €
2,70 €
3,00 €
5,30 €

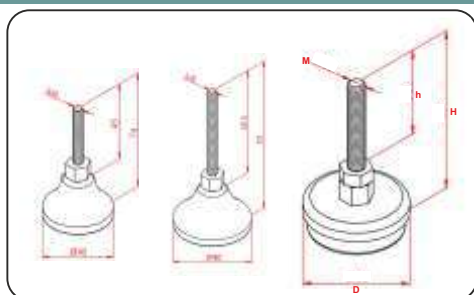

Code	Product Name	D	M	H	h	Material	Weight	Load Capacity
<b>MF 62/A</b>	M6 Metal Foot Simple	Ø 40	M6	80	50	Steel	150 gr	130 kg
<b>MF 62/B</b>	M8 Metal Foot Simple	Ø 40	M8	80	50	Steel	250 gr	180 kg
<b>M 62/C</b>	M10 Chrome Coated Metal Levelling Feet	Ø 60	M10	103	70	Chrome-steel	188 gr	190 kg
<b>M 62/B</b>	M12 Chrome Coated Metal Levelling Feet	Ø 80	M12	146	100	Chrome-steel	479 gr	489 kg
<b>M 62/A</b>	M16 Chrome Coated Metal Levelling Feet	Ø 120	M16	146	100	Chrome-steel	1.081 gr	1.150 kg

TIMH KOMMATI
6,50 €
7,00 €
7,00 €
8,40 €
15,00 €

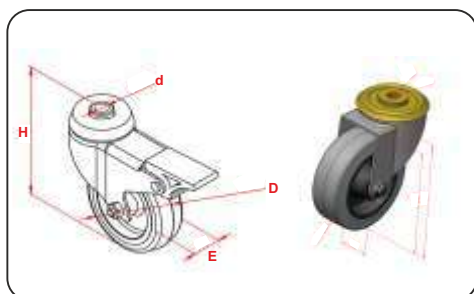

Code	Product Name	E	ØD	Ød	H	Load Capacity	Material	Weight
<b>M 99/A</b>	Ρόδα τρελή Φ 50	24	50	10	70	50 kg	Polyamid	204 gr
<b>M 99/B</b>	Ρόδα τρελή Φ 50 με φρένο	24	50	10	70	50 kg	Polyamid	277 gr
<b>M 99/C</b>	Ρόδα τρελή Φ 75	24	75	10	100	70 kg	Polyamid	298 gr
<b>M 99/D</b>	Ρόδα τρελή Φ 75 με φρένο	24	75	10	100	70 kg	Polyamid	538 gr
<b>M 99/E</b>	Ρόδα τρελή Φ 100	24	100	12	130	80 kg	Polyamid	719 gr
<b>M 99/F</b>	Ρόδα τρελή Φ 100 με φρένο	24	100	12	130	80 kg	Polyamid	820 gr

TIMH KOMMATI
3,50 €
4,50 €
4,50 €
5,50 €
6,00 €
6,50 €

ΚΑΤΟΠΙΝ ΖΗΤΗΣΗΣ ΥΠΑΡΧΟΥΝ ΚΑΙ ΣΕ ΑΛΛΕΣ ΔΙΑΜΕΤΡΟΥΣ

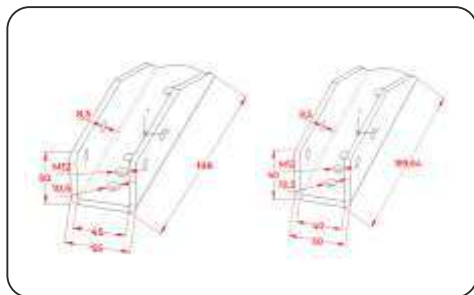

Code	Product Name	A	B	C	L	ØD	Ød	Material	Weight
<b>MF 4080</b>	40x80 (40x40) Con. piece M12	50	40	40	189.64	10.50	8.50	Steel Zinc	729 gr
<b>MF 4590</b>	45x90 (45x45) Con. piece M12	55	45	50	198.00	10.50	8.50	Steel Zinc	885 gr

TIMH  
KOMMATI  
**9,00 €**  
**10,00 €**

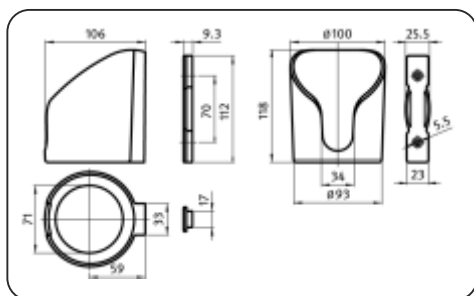

Code	Product Name	A	B	C	L	ØD	Ød	Material	Weight
<b>MF 79</b>	Cupholder	106	25.5	23	112	100	5.5	PP	145.6 gr

TIMH  
KOMMATI  
**7,30 €**

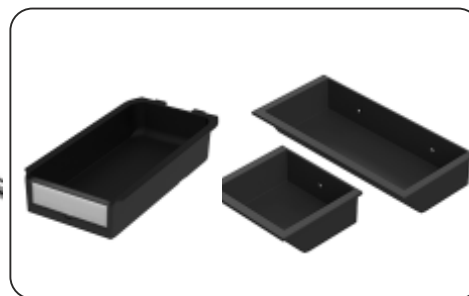
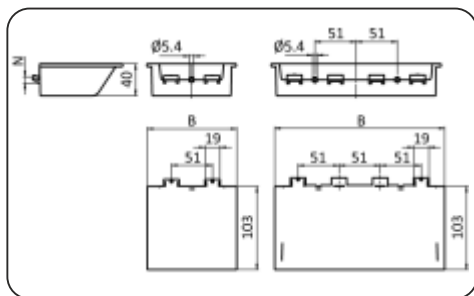

Code	Product Name	A	B	C	L	N	Ød	Material	Weight
<b>MF 110</b>	Grab Container 110x105x40 S10	110	105	51	103	40	5.40	PP	95.2 gr
<b>MF 210</b>	Grab Container 210x105x40 S10	210	105	51	103	40	5.40	PP	190.8 gr

TIMH  
KOMMATI  
**3,50 €**  
**4,50 €**

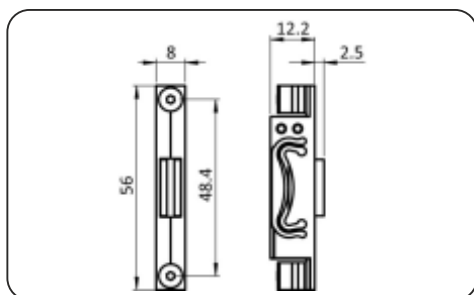

Code	Product Name	A	B	C	L	N	Ød	Material	Weight
<b>MF 56</b>	Metal Magnetic Sensor Holder S8	12.2	48.4	12.2	56	2.5	8	Polyamide	11.2 gr

TIMH  
KOMMATI  
**6,30 €**

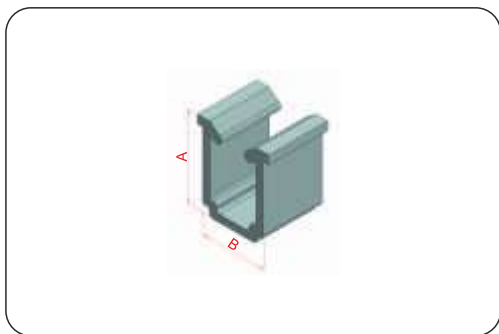

Code		Product Name	Color	A	B	Material	Weight
<b>U 8</b>	Slot 8	In Slot U 8 seal	●	9	8,2	PVC	44,6 gr
<b>U 10</b>	Slot 10	In Slot U 10 seal	●	14,00	10,20	PVC	50,6 gr

TIMH BEPΓAΣ  
3 METPΩN

4,00 €

5,00 €

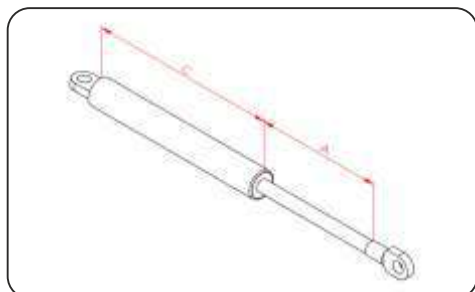
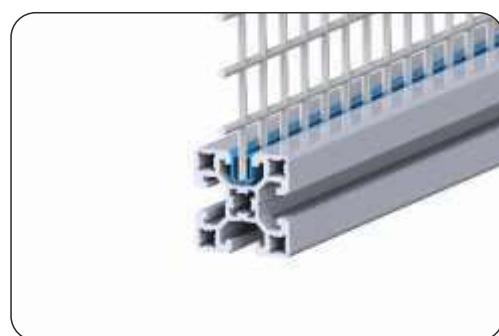

Code	Product Name	A	B	H Min. Max	Material	Weight
<b>M 84</b>	Absorbers (Strok 150mm) F300N	150	195	233 - 383	Steel	205 gr
<b>M 84/B</b>	Absorbers (Strok 105mm) F150N	105	145	188 - 293	Steel	159 gr
<b>M 84/C</b>	Absorbers (Strok 85mm) F85N	85	130	168 - 253	Steel	148 gr

TIMH KOMMATI

10,40 €

9,50 €

9,00 €

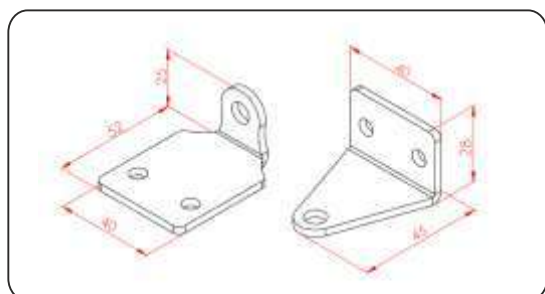

Code	Product Name	Material	Weight
<b>M 84/D - M84/F</b>	Absorber Connection Part	Steel	48 gr

TIMH KOMMATI

3,50 €

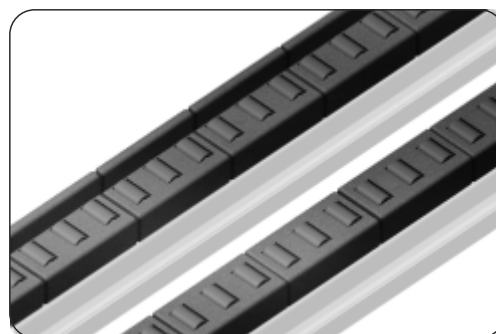
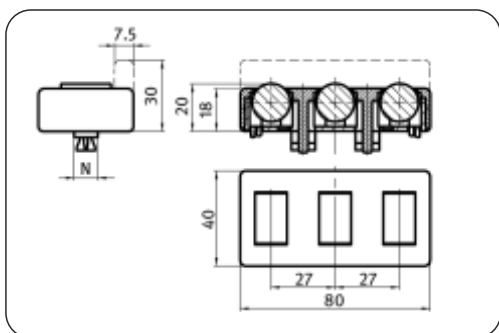
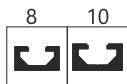

Code	Product Name	A	B	C	N	H	Material	Weight	TIMH KOMMATI
FR 8040	40x80 Roller Clip-fix	40	80	20	8.38-10.38	30	Plastic PA	43.3 gr	4,00 €
FR 8040/G	40x80 Roller Clip-fix with lateral guide	40	80	20	8.38-10.38	30	Plastic PA	48 gr	4,20 €

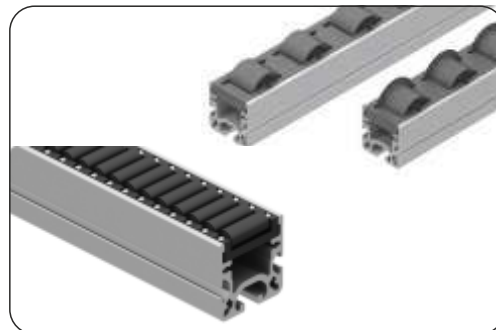
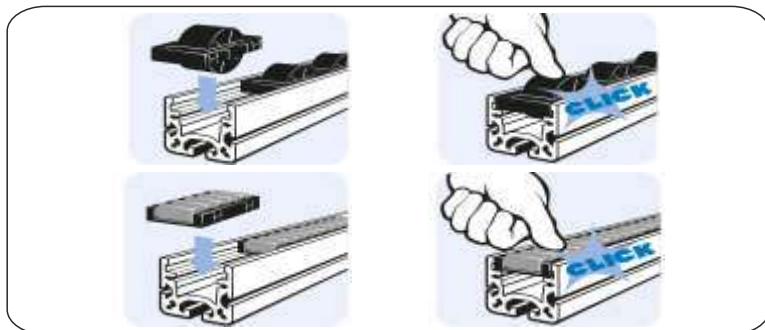
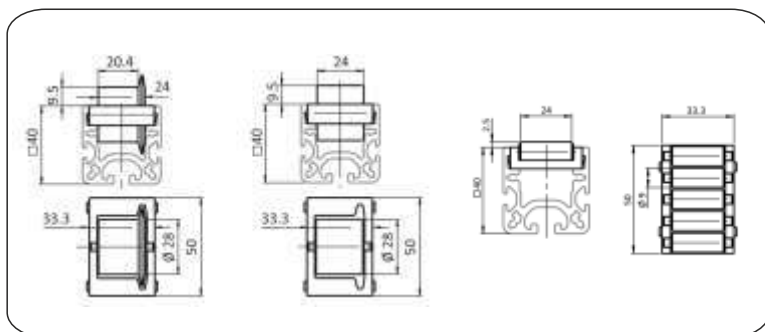

Code	Product Name	A	B	C	W	W1	D	Max load	Color	Material	Weight	TIMH KOMMATI
FR 28	Roller Element R28 Black	50	33.3	20.4	24	20.4	28	150 N	Black	Plastic PA	19 gr	0,97 €
FR 28/R	Roller Element R28 Red	50	33.3	20.4	24	20.4	28	150 N	Red	Plastic PA	19 gr	0,99 €
FR 28/G	Roller Element R28 Grey	50	33.3	20.4	24	20.4	28	150 N	Grey	Plastic PA	19 gr	0,99 €
FR 28/F	Roller Element R28 with flange Black	50	33.3	20.4	23.8	20.4	28	150 N	Black	Plastic PA	20 gr	0,99 €
FR 90	Roller Element R9 Black	50	40	24	33.3	24	24	100 N	Black	Plastic PA	30 gr	2,55 €



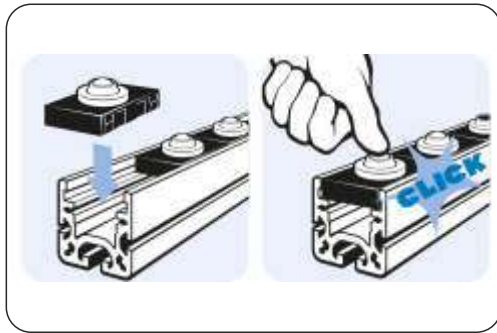
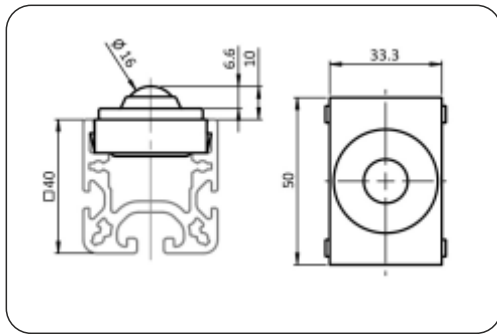

Code	Product Name	A	B	C	W	Ø	Color	Material	Weight
FR 50	Ball Element	50	33.3	10	6.6	16	Black cage chrome ball	PA & steel chrome	71 gr

TIMH  
KOMMATI  
**6,20 €**

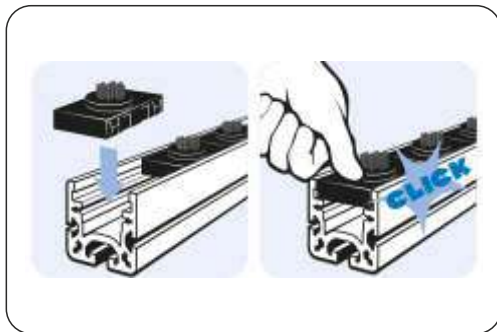
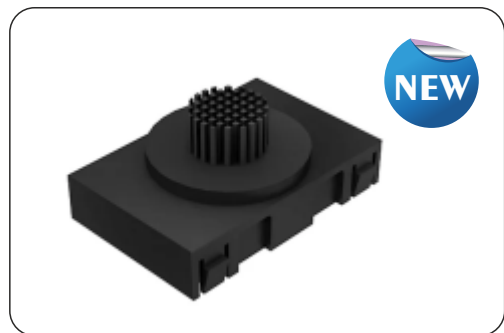
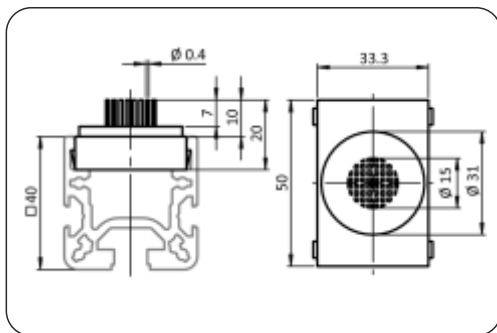

Code	Product Name	A	B	C	W	H	Ø1	Ø2	Ø3	Color	Material	Weight
FR 50/B	Brush Element	50	33.3	10	20	7	31	15	0.4	Black	Plastic PA	14 gr

TIMH  
KOMMATI  
**7,20 €**

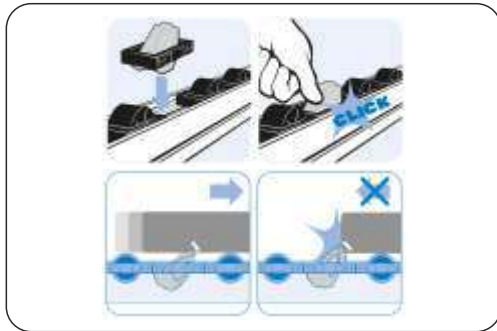
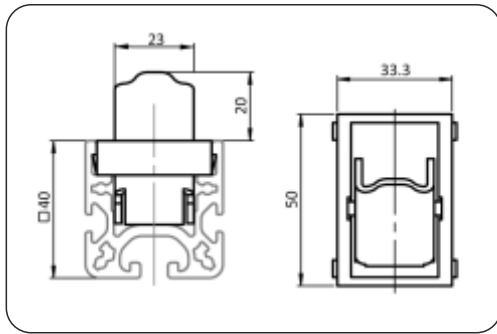

Code	Product Name	A	B	C	W	H	Color	Material	Weight	TIMH KOMMATI
FR 50/S	Back stop Element	50	33.3	23	33.3	20	Black cage Chrome stop	Steel zinc	44 gr	12,40 €

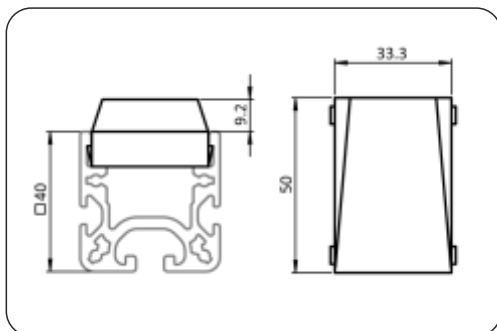

Code	Product Name	A	B	W	H	Color	Material	Weight	TIMH KOMMATI
FR S20	Slide ramp Unit	50	33.3	33.3	9.2	Black	Plastic PA	15 gr	2,10 €

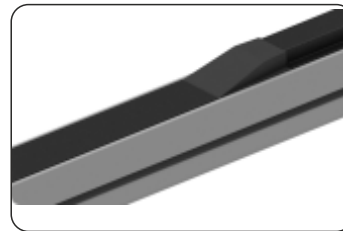
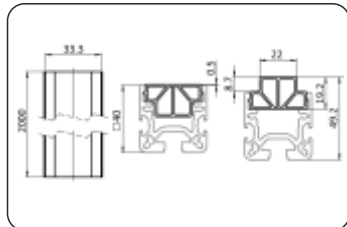

ΜΗΚΟΣ ΒΕΡΓΑΣ 2000 mm

Code	Product Name	A	B	L	W	H	Color	Material	Weight
FR L20	Slide strip	22	33.3	2000	0.5	19.2	Black	Plastic PE-HD	324 gr

TIMH METPO
7,15 €

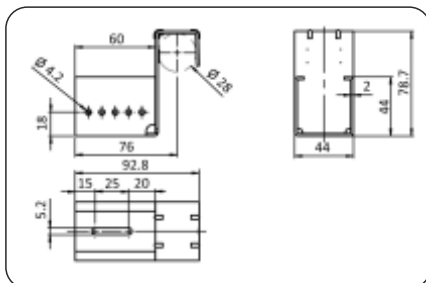

FR 28M  
FR 28M/S

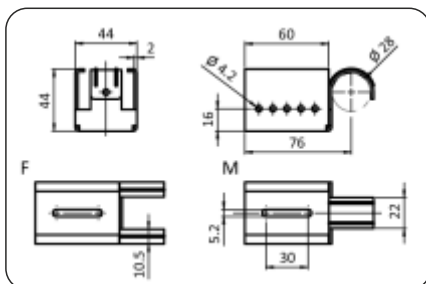
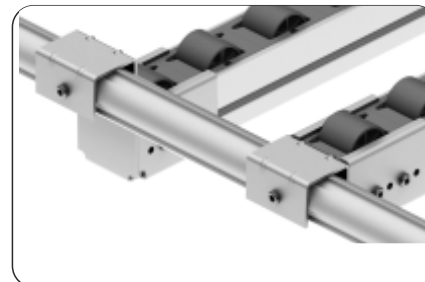
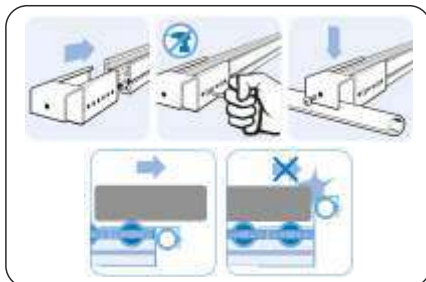

FR 28/D

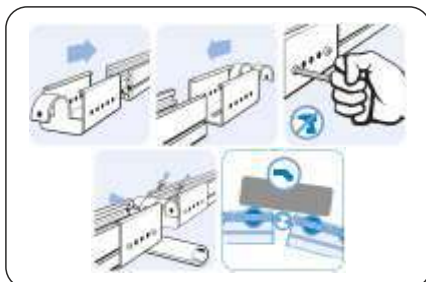

Code	Product Name	A	B	L	H	Ø1	Ø2	Material	Weight
FR 28M	Holding Bracket	44	60	92.8	78.7	28	4.2	Steel	198.5 gr
FR 28M/S	Holding Bracket with stop	44	60	92.8	78.7	28	4.2	Steel	198.5 gr
FR 28/D	Variable Holding inner Bracket	44	44	60	43	28	4.2	Steel	144 gr

TIMH KOMMATI
5,70 €
6,40 €
6,30 €

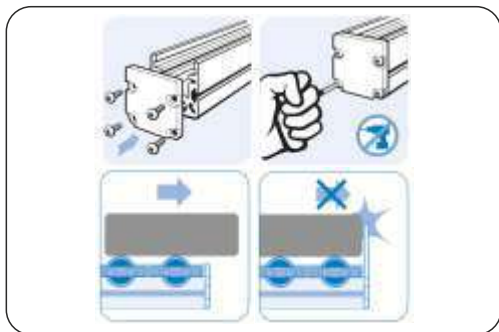
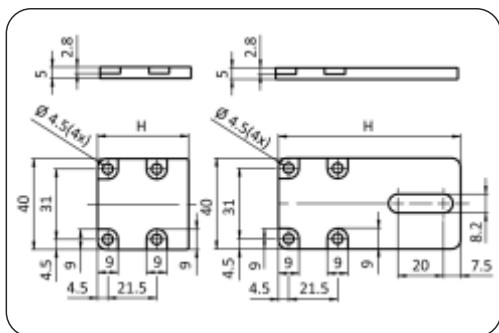

Code	Product Name	A	B	L	H	Ø1	Ø2	Material	Weight	TIMH KOMMATI
<b>FR 4040</b>	End Plate 40x40	40	31	40	40	4.5	4.5	Steel	55 gr	<b>4,20 €</b>
<b>FR 4080</b>	End Plate 40x80	40	31	80	40	4.5	4.5	Steel	108 gr	<b>6,00 €</b>

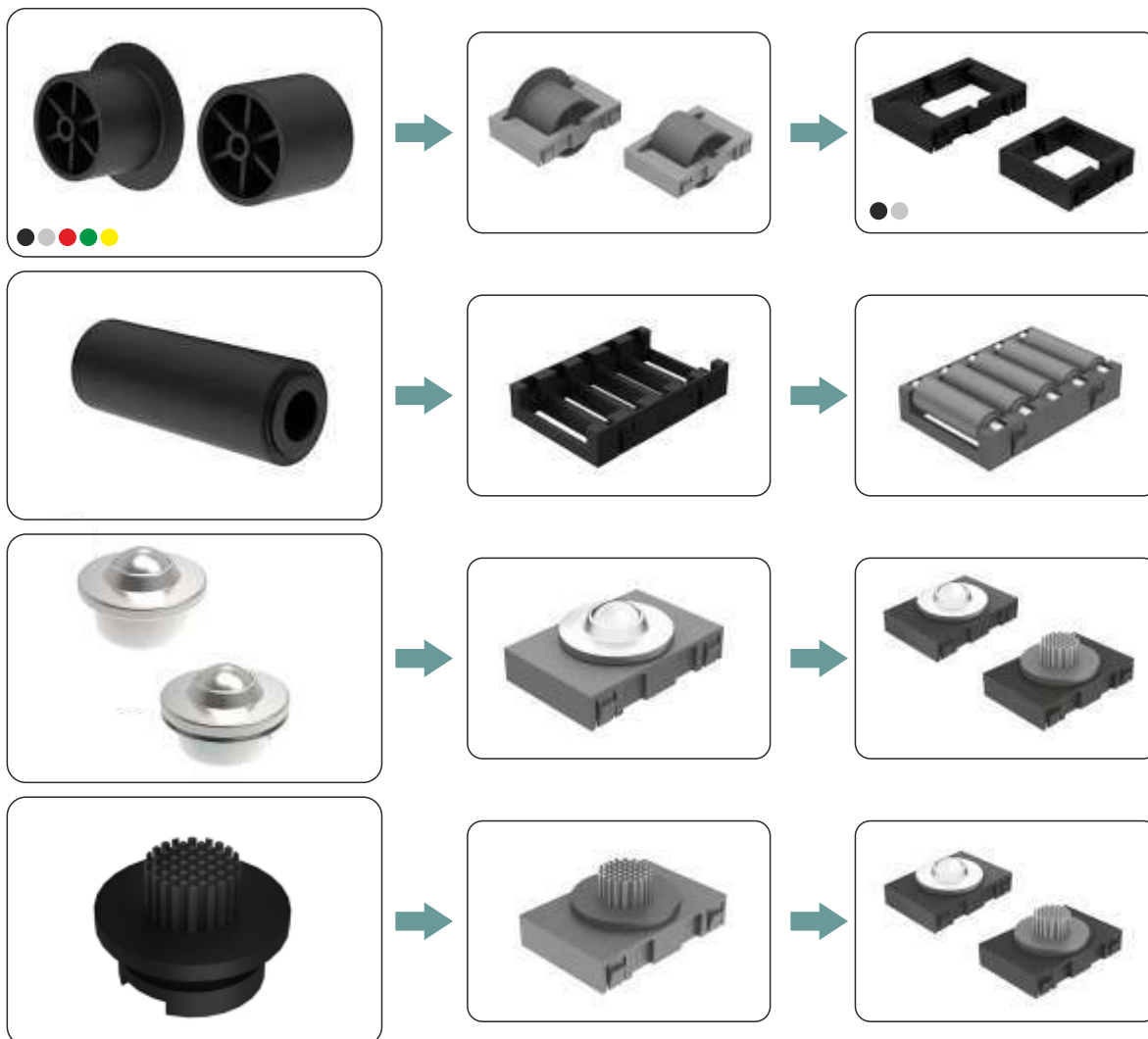

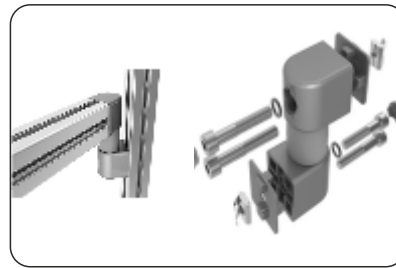
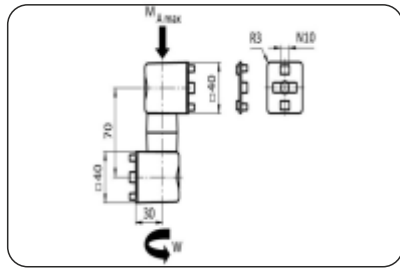

Code	Product Name	Friction Torque	M <small>(min deep 15 mm)</small>	L	B	Material	Weight
<b>FB 40L/3</b>	40x40 Friction Joint Set for Arm System	3 N•m	8	40	40	Steel	775 gr

TIMH KOMMATI  
**108,50 €**

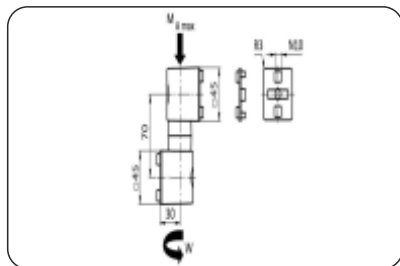

Code	Product Name	Friction Torque	M <small>(min deep 15 mm)</small>	L	B	Material	Weight
<b>FB 45L/6</b>	45x45 Friction Joint Set for Arm System	6 N•m	8	45	45	Steel	825.4 gr

TIMH KOMMATI  
**114,00 €**

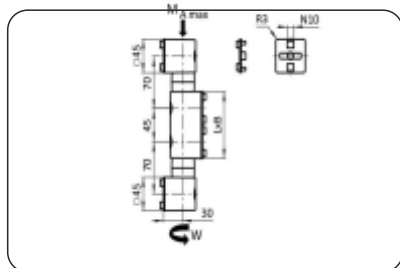

Code	Product Name	Friction Torque	M <small>(min deep 15 mm)</small>	L	B	Material	Weight
<b>FB 90H/D9</b>	45x90 D Friction Joint Set for Arm System	2x9 N•m	8	90	45	Steel	1669.4 gr

TIMH KOMMATI  
**210,40 €**

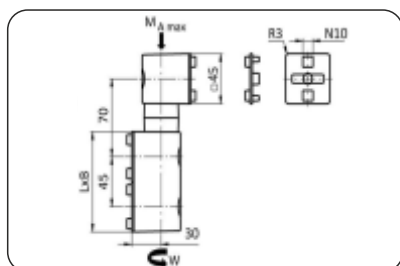

Code	Product Name	Friction Torque	M <small>(min deep 15 mm)</small>	L	B	Material	Weight
<b>FB 90L/6</b>	45x90 Friction Joint Set for Arm System	6 N•m	8	90	45	Steel	1159.2 gr

TIMH KOMMATI  
**127,10 €**

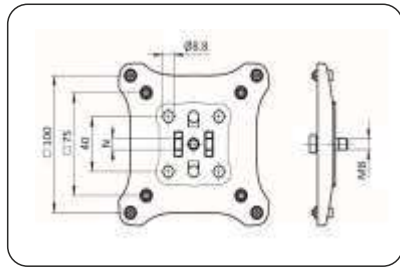

Code	Product Name	A	B	C	ØD	Material	Weight
<b>MMF 75/100</b>	Monitor Plate 75/100	100	75	40	8.8	PA Plastic +Fiberglass	123 gr

TIMH KOMMATI  
**19,80 €**

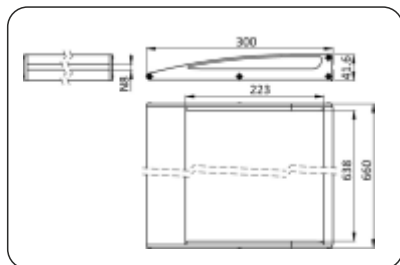

Code	Product Name	A	B	C	H	N	K	Material	Weight
<b>MF 80K</b>	Keyboard Holder	660	638	300	41.6	8	223	Aluminium Anodized	4900 gr

TIMH KOMMATI  
**100,00 €**



**Αλενόβιδες σε μετρικό DIN912** INOX A2

Πάχος →	3	4	5	6	8	10	12	14	16
↓ Μήκος ↓									
3-6	2,47€	3,82€							
8	2,60€	4,39€	4,58€						
10	2,16€	4,20€	4,39€	6,61€	14,43€				
12	2,21€	3,82€	4,39€	6,64€	14,88€				
16	2,24€	4,20€	4,20€	6,42€	13,28€	30,18€			
20	2,70€	4,20€	4,77€	6,68€	14,25€	22,04€	33,57€		
25	3,38€	4,20€	5,73€	7,80€	15,10€	24,90€	33,57€	73,06€	59,87€
30	3,38€	5,73€	6,87€	9,15€	17,15€	25,19€	35,67€	77,83€	83,55€
35	4,68€	6,49€	8,25€	10,80€	18,75€	27,28€	39,83€	70,77€	88,13€
40	5,98€	7,25€	8,97€	12,14€	21,75€	29,38€	44,07€	70,96€	92,52€
45		7,63€	10,49€	13,71€	26,32€	33,58€	46,79€	77,27€	97,63€
50		8,40€	11,45€	15,34€	27,47€	35,67€	49,32€	84,32€	104,54€
60			13,93€	19,28€	27,92€	44,07€	56,65€	96,34€	117,70€
70				22,89€	38,91€	52,45€	62,95€	119,85€	129,71€
80				27,60€	45,79€	62,95€	73,45€	130,67€	151,27€
90				42,35€	57,23€	72,67€	88,13€	143,07€	171,69€
100				54,48€	61,81€	87,70€	95,08€	154,90€	188,28€
110					64,47€	91,00€	117,00€		
120					68,90€	97,50€	132,95€		
130					74,10€	117,00€	144,30€		
140					80,60€	126,10€	159,25€		
150					87,10€	136,50€	174,20€		

\*τα 100 τεμάχια

**Αλενόβιδες φρεζάτες DIN7991** INOX A2

Πάχος →	4	5	6	8	10	12
↓ Μήκος ↓						
10	4,07€	4,90€	8,13€			
12	4,34€	5,44€	5,96€			
16	4,61€	5,44€	6,24€	11,40€		
20	5,16€	5,46€	6,78€	12,60€	21,70€	48,82€
25	6,78€	6,78€	8,40€	14,64€	22,86€	50,25€
30	7,60€	7,86€	9,30€	15,74€	27,12€	54,24€
35	9,50€	9,50€	10,30€	18,71€	30,91€	58,25€
40	11,06€	11,40€	11,94€	19,95€	33,95€	62,45€
45		14,13€	14,68€	23,45€	38,13€	70,62€
50		16,95€	16,95€	26,84€	47,87€	76,23€
60			19,78€	38,14€	56,50€	98,87€
70				51,86€	73,22€	116,62€
80				61,01€	82,37€	134,23€

\*τα 100 τεμάχια

**Αλενόβιδες πομπές DIN7380**

INOX A2



Πάχος →	4	5	6	8	10
↓ Μήκος ↓					
10	4,32€	6,78€			
12	4,68€	6,87€			
16	5,40€	6,39€	8,55€	16,83€	
20	6,12€	7,07€	9,90€	15,66€	38,25€
25	6,84€	7,92€	11,25€	21,42€	42,84€
30	7,92€	9,45€	13,59€	23,58€	45,90€
35		11,70€	14,94€	27,54€	53,55€
40		12,83€	16,38€	31,23€	58,14€
50			21,42€	39,20€	64,26€
60				48,96€	

\*τα 100 τεμάχια

ΟΙ ΤΙΜΕΣ ΜΠΟΡΟΥΝ ΝΑ ΑΛΛΑΞΟΥΝ ΧΩΡΙΣ ΠΡΟΕΙΔΟΠΟΙΗΣΗ

Ροδέλες DIN125 INOX A2

Τύπος	Τιμή	Τύπος	Τιμή
3X7	0,70 €	18X34	17,60 €
4X9	0,70 €	20X37	18,24 €
5X10	0,94 €	22X39	22,56 €
6X13	1,35 €	24X44	38,80 €
8X17	2,25 €	27X50	66,40 €
10X21	4,14 €	30X56	80,80 €
12X24	7,44 €	33X60	100,00 €
14X28	10,80 €	36X66	222,40 €
16X30	11,88 €		*τα 100 τεμάχια

Ροδέλες φαρδιές DIN9021 INOX A2

Τύπος	Τιμή	Τύπος	Τιμή
3X9	0,81 €	16X50	43,96 €
4X12	1,10 €	18X56	61,54 €
5X15	1,74 €	20X60	70,33 €
6X18	3,66 €	22X66	124,80 €
8X25	7,14 €	24X72	174,72 €
10X30	15,30 €	27X81	217,60 €
12X40	23,10 €		*τα 100 τεμάχια
14X45	31,14 €		

Ντίζες DIN976 1 μέτρου INOX A2

Πάχος	Τιμή	Πάχος	Τιμή
3	1,89€	16	15,96€
4	1,96€	18	22,76€
5	1,86€	20	25,53€
6	2,45€	22	31,91€
8	3,63€	24	35,12€
10	5,32€	27	51,07€
12	7,45€	30	63,83€
14	11,28€	33	90,00€

Γκρόβερ DIN127B INOX A2

Οπή	Τιμή	Οπή	Τιμή
3	0,41 €	16	10,28 €
4	0,41 €	18	10,89 €
5	0,83 €	20	15,41 €
6	1,23 €	22	16,44 €
8	2,06 €	24	24,65 €
10	2,88 €	27	58,10 €
12	5,25 €	30	56,00 €
14	6,58 €		*τα 100 τεμάχια

Ανοξείδωτα περικόχλια DIN934 INOX A2

Πάχος	Τιμή	Πάχος	Τιμή
2	2,46 €	16	36,40 €
2,5	1,75 €	18	46,69 €
3	1,86 €	20	64,40 €
4	1,62 €	22	87,32 €
5	1,79 €	24	102,72 €
6	3,06 €	27	304,04 €
8	6,36 €	30	361,56 €
10	11,76 €	33	558,60 €
12	17,22€	36	651,00 €
14	25,41 €		*τα 100 τεμάχια

Περικόχλια ασφαλείας DIN985 INOX A2

Πάχος	Τιμή	Πάχος	Τιμή
3	2,94€	14	49,71 €
4	2,94 €	16	58,76 €
5	2,94€	18	189,82 €
6	3,40 €	20	189,82 €
8	9,30 €	22	221,31 €
10	15,19 €	24	370,60 €
12	22,05€		*τα 100 τεμάχια

Περικόχλια τυφλά DIN1587 INOX A2

Πάσο	Τιμή	Πάσο	Τιμή
3	7,48 €	12	48,18 €
4	7,48 €	14	82,41 €
5	7,74 €	16	107,76 €
6	8,37 €	18	190,17 €
8	14,06 €	20	228,20 €
10	33,63 €		*τα 100 τεμάχια

Περικόχλια πεταλούδες DIN315AF INOX A2

Πάσο	Τιμή
3	14,97€
4	14,97€
5	14,97 €
6	20,25€
8	23,95€
10	40,50 €
12	86,28 €
14	154,96 €
16	158,48 €
	*τα 100 τεμάχια





**Μηχανόβιδες φρεζάτες DIN963** INOX A2



Πάχος→	3	4	5	6	8	10
↓Μήκος↓						
3-7	1,48€	1,97€	3,70€			
8	1,48€	1,97€	3,70€			
10	2,23€	2,47€	3,70€	4,93€		
12	2,23€	2,47€	4,45€	4,93€		
16	2,23€	2,72€	4,93€	5,92€		
20	2,23€	2,97€	5,18€	6,16€		
25	2,47€	3,47€	5,67€	8,14€		
30	2,47€	3,70€	6,41€	8,88€		
35	4,93€	4,69€	6,66€	9,86€		
40	3,70€	5,18€	7,15€	10,85€		
45			7,40€	11,59€		
50		6,41€	7,64€	12,57€		
60		7,15€	10,35€	14,79€		
70				19,60€		
80				27,22€	55,78€	84,67€
90				34,27€	60,28€	
100				48,72€	66,66€	117,60€
120					95,06€	176,40€

\*τα 100 τεμάχια

**Μηχανόβιδες τραπεζοειδείς - φρεζάτες DIN7985 - DIN965** INOX A2



Πάχος→	2	2,5	3	4	5	6	8
↓Μήκος↓							
4				3,15€			
6	2,40€	2,40€	2,49€	2,34€			
7	2,40€	2,40€					
8	2,40€	2,40€	2,70€	3,87€	4,39€		
10	2,40€	2,40€	2,08€	4,08€	5,17€		
12	2,40€	2,40€	2,82€	3,28€	7,90€	8,27€	
16	2,80€	2,80€	2,52€	5,10€	6,46€	8,53€	20,66€
20	2,85€	2,80€	2,68€	5,55€	9,48€	10,89€	23,50€
25			4,50€	4,44€	10,92€	13,08€	25,06€
30			3,08€	7,26€	12,84€	12,66€	26,60€
35				7,62€	13,68€	13,43€	26,86€
40			7,71€	6,84€	16,92€	14,46€	29,45€
45				8,00€	12,76€	15,50€	32,29€
50				12,30€	17,22€	24,27€	42,62€
60				11,88€	22,68€	23,40€	45,20€
70					24,28€	35,80€	
80					29,31€	50,40€	
100						52,53€	

\*τα 100 τεμάχια

**Μηχανόβιδες πλατυκέφαλες WS9330**

INOX A2



(Τσιγκόβιδες)



Πάχος→	3	4	5	6	8
↓Μήκος↓					
10	11,90€	7,94€	11,90€	18,17€	
12	12,57€	9,58€	12,57€	18,17€	
16	13,56€	11,24€	15,19€	19,17€	46,92€
20	14,54€	12,23€	17,52€	19,82€	50,11€
25	16,53€	12,57€	19,82€	23,13€	59,13€
30	18,17€	15,19€	21,38€	25,11€	65,07€
35			25,43€	31,72€	55,82€
40		17,52€	31,07€	34,03€	63,42€
50			31,72€	40,97€	63,42€
60			40,30€	41,30€	72,81€

\*τα 100 τεμάχια

**Μηχανόβιδες τραπεζοειδείς DIN84**

INOX A2



Πάχος→	3	4	5	6
↓Μήκος↓				
3-8	3,84€	4,28€	6,08€	
10	3,68€	4,56€	6,48€	7,80€
12	3,84€	5,28€	6,72€	8,16€
16	4,16€	3,92€	7,28€	9,12€
20	4,40€	4,28€	7,92€	10,08€
25	4,64€	5,48€	8,56€	11,24€
30	4,96€	6,24€	9,76€	12,96€
35		6,72€	10,64€	14,00€
40		8,56€	11,84€	15,20€
45			12,20€	17,12€
50			13,44€	17,68€
60			15,84€	22,00€

\*τα 100 τεμάχια

**Μηχανόβιδες φακής DIN966 INOX A2**



Πάχος→	3	4	5	6	Πάχος→	3	4	5	6
↓Μήκος↓					↓Μήκος↓				
6	2,00€	2,80€			25	4,40€	6,60€	10,00€	15,50€
8	2,00€	3,00€			30	6,20€	7,60€		17,20€
10	2,20€	3,30€	5,50€	10,00€	35		8,80€	13,60€	20,60€
12	2,50€	3,60€	6,00€	10,00€	40		10,00€	15,00€	22,00€
16	2,70€	4,40€		10,80€	50				28,80€
20	3,60€	5,30€	8,40€	12,50€	60			22,50€	33,00€

\*τα 100 τεμάχια



**Μηχανόβιδες πομπέ WS9460 INOX A2**



Πάχος→	4	5	6
↓Μήκος↓			
8	4,00€	6,80€	
10	4,00€	7,00€	12,00€
12	4,40€	7,30€	12,60€
16			13,20€
25	6,60€	11,00€	
30	9,30€	12,50€	19,00€
35		17,00€	25,50€
40		17,00€	28,50€

\*τα 100 τεμάχια

**Μηχανόβιδες φρεζάτες WS9470 INOX A2**



Πάχος→	4	5	6
↓Μήκος↓			
10	6,40€	9,00€	
12		9,20€	12,60€
16		10,50€	
20		11,00€	
25		14,64€	19,20€
30			21,60€

\*τα 100 τεμάχια

**Μηχανόβιδες πεταλούδα DIN316AF INOX A2**



Πάχος→	4	5	6	8
↓Μήκος↓				
16	60,00€	60,00€	66,00€	124,00€
20	60,00€	60,00€	68,00€	128,00€
25	83,00€	65,00€	74,00€	130,00€
30	83,00€	66,00€	89,00€	140,00€
40			89,03€	140,05€
50			95,15€	188,00€

\*τα 100 τεμάχια

**Κασονόβιδες DIN603 INOX A2**



Πάχος→	6	8	10	12	Πάχος→	6	8	10	12
↓Μήκος↓					↓Μήκος↓				
20	16,54€	23,59€			90	34,16€	75,11€	113,89€	132,34€
25	18,45€	23,59€	44,75€	84,07€	100	37,17€	82,67€	125,28€	146,57€
30	20,34€	30,30€	46,37€	84,07€	110			134,77€	159,17€
35	22,51€	29,82€	48,27€	87,32€	120		125,79€	140,23€	161,34€
40	24,41€	27,13€	52,33€	90,85€	130		134,75€	149,42€	168,13€
45	26,30€	30,37€	53,97€	94,36€	140		140,14€	158,10€	175,44€
50	27,73€	33,85€	56,13€	101,77€	150		181,65€	164,05€	244,06€
60	28,47€	44,75€	84,07€	107,11€	160				337,26€
70	30,65€	46,36€	88,94€	115,51€	180				436,13€
80	31,47€	49,62€	102,50€	123,38€					

\*τα 100 τεμάχια

**Μεντεσέδες σωλήνων M8136 INOX A4**



L	D	H	Τιμή
70mm	20mm	25mm	4,30€

**Μεντεσέδες με διπλό πύρο M8018 INOX A4**

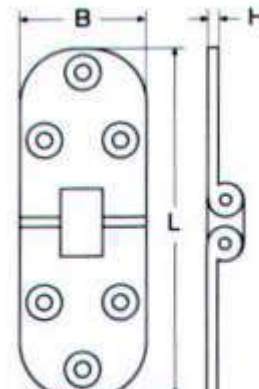

L	B	H	Τιμή
80mm	30mm	1,5mm	8,80€

**Μεντεσέδες χυτοί M8233 INOX A4**

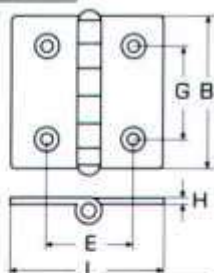

L	B	G	E	H	Τιμή
38mm	38mm	25mm	25mm	4mm	6,85€
50mm	50mm	32mm	35mm	4mm	9,72€

**Μεντεσέδες χυτοί M8234 INOX A4**

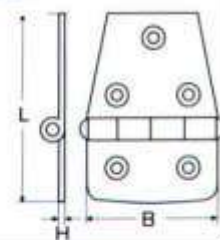

L	B	H	Τιμή
57mm	38mm	4,5mm	5,12€
76mm	38mm	4,5mm	6,88€

**Μεντεσέδες χυτοί στρόγγυλοι M8428 INOX A4**

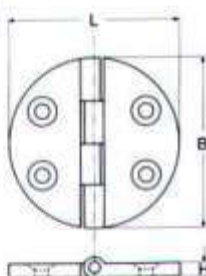

L	B	H	Τιμή
64mm	64mm	4mm	6,03€

**Μεντεσέδες M8429 INOX A4**

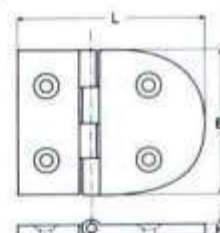

L	B	H	Τιμή
81mm	64mm	4mm	16,33€

**Μεντεσέδες με πύρο M8238 INOX A4**

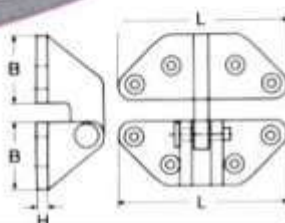

L	B	H	Τιμή
71mm	28mm	6mm	16,80€

**Μεντεσέδες μακρόστενοι M8235 INOX A4**

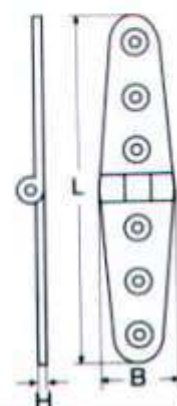

L	B	H	Τιμή
103mm	27mm	4,5mm	5,36€
152mm	30mm	4,5mm	7,36€

**Μεντεσέδες με γόνατο M8237 INOX A4**

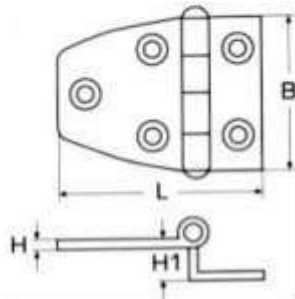

L	B	H	H1	Τιμή
54mm	37mm	4,5mm	14mm	5,62€
70mm	37mm	4,5mm	14mm	6,80€

**Μεντεσέδες χυτοί διαρούμενοι M8239 INOX A4**

\*η φωτογραφία δείχνει δεξιό

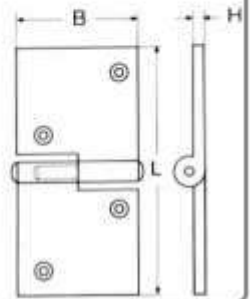

Τύπος	L	B	H	Τιμή
Αριστερός	92mm	36mm	5mm	10,40€
Δεξιός	92mm	36mm	5mm	10,40€

**Μεντεσέδες χυτοί M8280 INOX A4**

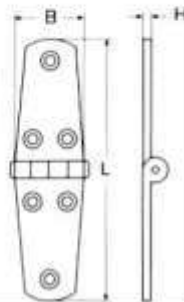

Τύπος	L	B	H	Τιμή
A	76mm	38mm	4,5mm	7,44€
B	102mm	38mm	4,5mm	8,48€

**Μεντεσέδες χυτοί τύπου "T" M8281 INOX A4**

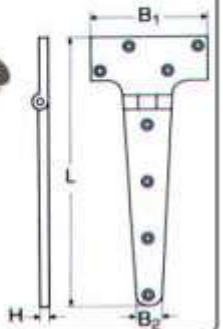

L	B1	B2	H	Τιμή
195mm	98mm	20mm	5mm	25,76€

**Μεντεσέδες οβάλ M8045 INOX A4**

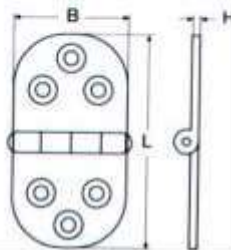

L	B	H	Τιμή
47mm	30mm	1,5mm	2,90€
75mm	40mm	1,5mm	4,80€
80mm	40mm	2,5mm	4,05€

**Μεντεσέδες μακρόστενοι M8046 INOX A4**

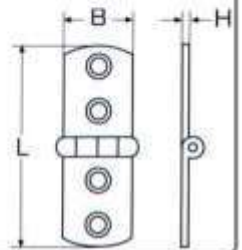

L	B	H	Τιμή
75mm	20mm	1,5mm	3,83€
85mm	30mm	1,5mm	3,61€
100mm	40mm	1,5mm	5,22€

**Μεντεσέδες μακρόστενοι M8047 INOX A4**

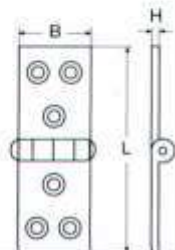

L	B	H	Τιμή
80mm	20mm	1,5mm	3,06€
90mm	30mm	1,5mm	3,51€
100mm	40mm	1,5mm	3,92€

**Μεντεσέδες M8043 INOX A4**

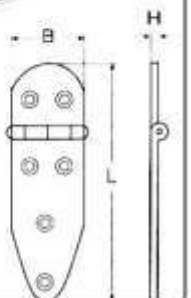

L	B	H	Τιμή
130mm	40mm	1,5mm	5,09€

**Μεντεσέδες M8049 INOX A2**

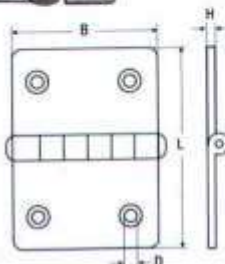

	B	L	H	D	Τιμή
A	30	40	1,53,9	3,43€	
B	40	40	1,54,5	2,81€	
C	40	60	1,54,5	3,15€	
D	50	60	1,55,5	3,68€	
E	60	60	1,54,5	4,08€	
F	50	80	1,54,5	6,03€	
G	60	80	1,54,5	4,80€	
H	70	80	1,54,5	6,24€	
I	80	80	1,54,5	7,25€	
P	100	100	1,54,5	10,54€	

**Μεντεσέδες M8150 INOX A2**

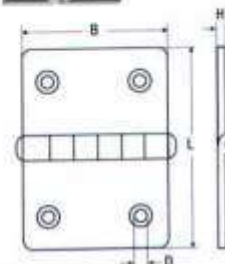

	B	L	H	D	Τιμή
A	25	300,84,5	2,41€		
B	28,5	300,84,5	2,51€		
C	35	400,84,5	2,34€		
D	40	400,84,5	2,67€		
E	40	500,84,5	2,02€		
F	50	500,84,5	1,72€		
G	50	600,84,5	2,24€		
H	55	700,84,5	2,67€		

**Μεντεσέδες πλακέ AKSSSN20 INOX A4**



Μήκος	Πλάτος	Πάχος	Τιμή
3"	3"	2mm	5,00€
3½"	3½"	2mm	6,00€
4"	3"	2mm	6,25€
4"	3½"	2mm	6,63€
4"	4"	2mm	7,00€

**Μεντεσέδες με ρουλεμάν AKSSSB20 INOX A4**



Μήκος	Πλάτος	Πάχος	Τιμή
3"	3"	2mm	5,50€
3½"	3½"	2mm	6,63€
4"	3"	2mm	7,00€
4"	3½"	2mm	8,00€
4"	4"	2mm	8,50€
4½"	4"	3mm	12,00€
4½"	4½"	3mm	13,00€

**Μεντεσέδες ρόμβου ART854 INOX A4**

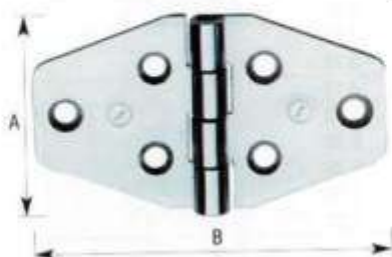

A	B	Τιμή
40mm	70mm	5,80€



**Μεντεσέδες ρόμβου κοφτοί ART852 INOX A4**

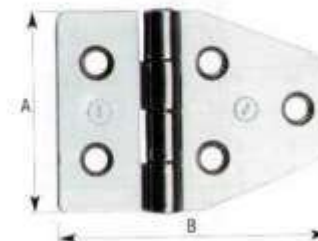

A	B	Τιμή
40mm	55mm	5,50€



**Μεντεσέδες διαιρούμενοι αριστεροί INOX 18/8**



Κωδικός	A	B	Τιμή
7324	60mm	40mm	2,12€
7326	70mm	50mm	2,75€



**Μεντεσέδες διαιρούμενοι δεξιοί INOX 18/8**



Κωδικός	A	B	Τιμή
7323	60mm	40mm	2,12€
7325	70mm	50mm	2,75€

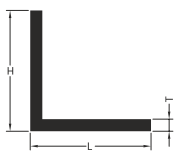

<b>Γωνίες   Corners</b>	Περιγραφή   Description (LxHxT)	Θ.Β. Weight	Περιγραφή   Description (LxHxT)	Θ.Β. Weight
	15x15x1,9	0,132	10x10x4,0	0,100
	20x20x1,5	0,160	30x20x1,50	0,200
	25x25x1,5	0,200	50x20x2,0	0,370
	30x30x1,5	0,240	60x60x3,0	0,950
	40x40x1,5	0,318	75x50x5,0	1,640
	40x20x1,5	0,240	60x20x1,5	0,320
	50x30x3,0	0,620	60x40x4,0	1,040
	50x50x2,0	0,530	80x40x4,0	1,250
	60x20x1,5	0,320	80x20x1,5	0,400
	100x20x2,0	0,640	100x100x8,0	4,150
100x50x5,0	1,960	120x20x2,0	0,750	

Ζητήστε μας τιμές

<b>Λάμες   Profiles</b>	Περιγραφή   Description (LxT)	Θ.Β. Weight	Περιγραφή   Description (LxT)	Θ.Β. Weight
	20x3	0,160	80x50	1,080
	20x5	0,270	80x10	2,160
	25x3	0,200	80x15	3,240
	25x5	0,340	100x8	2,160
	30x3	0,240	100x10	2,700
	40x5	0,540	100x20	5,400
	30x5	0,410	100x30	8,100
	30x10	0,810	120x10	3,240
	40x3	0,320	120x15	4,860
	40x5	0,540	120x20	6,480
	40x10	1,080	150x10	4,050
	40x15	1,620	150x15	6,080
	40x20	2,160	150x20	8,100
	50x3	0,410	200x10	5,400
	50x5	0,620	200x15	8,100
	50x8	1,080	200x20	10,800
	50x10	1,350	20x10	0,540
	60x3	0,490	40x8	0,860
	60x5	0,810	60x8	1,300
	60x10	1,620	95x11	2,822
60x15	2,430	95x11	2,822	

Ζητήστε μας τιμές

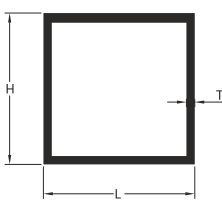
<b>Καρέ   Square</b>	Περιγραφή   Description (LxHxT)	Θ.Β. Weight	Περιγραφή   Description (LxHxT)	Θ.Β. Weight
	12x12x1,0	0,120	40x40x1,5	0,624
	15x15x1,5	0,220	50x50x1,5	0,786
	20x20x1,5	0,300	100x50x2,0	1,580
	25x25x1,5	0,380	60x20x1,5	0,620
	30x30x1,3	0,403	60x40x2,0	1,041
	40x20x1,5	0,460	80x20x1,3	0,684

Ζητήστε μας τιμές

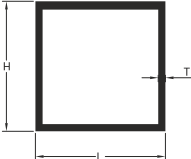
<b>Καρέ   Square</b>	Περιγραφή   Description (LxHxT)	Θ.Β. Weight	Περιγραφή   Description (LxHxT)	Θ.Β. Weight
	80x40x1,3	0,824	100x40x1,6	1,180
	80x80x1,8	1,520	100x50x2,0	1,580
	100x20x1,5	0,950	100x100x2,0	2,120
	120x20x1,6	1,180	100x100x4,0	4,150

Ζητήστε μας τιμές

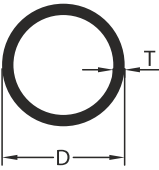
<b>Σωλήνες   Tubes</b>	Περιγραφή   Description (DxT)	Θ.Β. Weight	Περιγραφή   Description (DxT)	Θ.Β. Weight
	Φ8x1mm	0,060	Φ30x2mm	0,480
	Φ10x1mm	0,080	Φ32x2mm	0,510
	Φ12x2mm	0,170	Φ42,4x2mm	0,685
	Φ16x1,5mm	0,184	Φ50x2mm	0,814
	Φ16x3,5mm	0,370	Φ60x2mm	0,984
	Φ18x2,0mm	0,270	Φ70x2mm	1,154
	Φ20x1,85mm	0,285	Φ80x2mm	1,320
	Φ22x1,5mm	0,260	Φ100x2mm	1,663
	Φ25x2mm	0,390	Φ120x3mm	1,154
	Φ26x2mm	0,407		

Ζητήστε μας τιμές

<b>Λαμαρίνες Αλουμινίου</b>	Περιγραφή   Description (DxT)	Περιγραφή   Description (DxT)
	2000x1000x0.60 mm	2500x1250x0.60 mm
	2000x1000x0.80 mm	2500x1250x0.80 mm
	2000x1000x1.00 mm	2500x1250x1.00 mm
	2000x1000x1.50 mm	2500x1250x1.50 mm
	2000x1000x2.00 mm	2500x1250x2.00 mm
	2000x1000x3.00 mm	2500x1250x3.00 mm
	2000x1000x4.00 mm	2500x1250x4.00 mm
	2000x1000x5.00 mm	2500x1250x5.00 mm
	2000x1000x6.00 mm	2500x1250x6.00 mm
	2000x1000x8.00 mm	2500x1250x8.00 mm
	2000x1000x10.00 mm	2500x1250x10.00 mm
	2000x1000x12.00 mm	2500x1250x12.00 mm
	2000x1000x15.00 mm	2000x1000x20.00 mm

Ζητήστε μας τιμές

- ΜΠΟΡΟΥΝ ΝΑ ΚΟΠΟΥΝ ΚΑΙ ΝΑ ΕΠΕΞΕΡΓΑΣΤΟΥΝ ΚΑΤΟΠΙΝ ΠΑΡΑΓΓΕΛΙΑΣ
- ΕΠΙΣΗΣ ΥΠΑΡΧΟΥΝ ΛΑΜΑΡΙΝΕΣ ΤΥΠΟΥ ΚΡΙΘΑΡΑΚΙ & ΜΠΑΚΛΑΒΩΤΟ

**Η ΕΤΑΙΡΙΑ ΜΑΣ ΔΙΑΘΕΤΕΙ ΥΠΕΡΣΥΓΧΡΩΝΟ ΕΞΟΠΛΙΣΜΟ ΟΠΩΣ  
ΣΤΡΑΝΤΖΑ - ΨΑΛΙΔΙ - ΚΟΠΗ & ΚΟΛΛΗΣΗ LASER**



## ΤΙΜΟΚΑΤΑΛΟΓΟΣ

**ΕΞΑΡΤΗΜΑΤΑ ΒΙΟΜΗΧΑΝΙΚΩΝ ΜΕΤΑΦΟΡΕΩΝ  
ACCESSORIES CONVEYOR SYSTEMS**



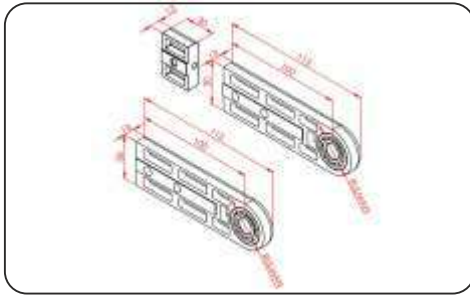

CODE	PRODUCT NAME	A	B	C	L	L1	Roller	Material	Weight
<b>TL 10</b>	30x30 Drive plate	8.2	30	13	115	100	61802	ΣΚΛΗΡΟ ΑΛΟΥΜΙΝΙΟ	96 gr
<b>TL 20</b>	45x45 Drive plate	10.2	45	13.6	152	129.5	1202	ΣΚΛΗΡΟ ΑΛΟΥΜΙΝΙΟ	210 gr

TIMH/TMX
<b>7,00 €</b>
<b>8,00 €</b>

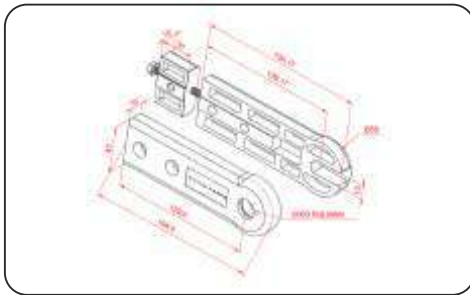

CODE	PRODUCT NAME	A	B	C	L	L1	Roller	Material	Weight
<b>TL 30</b>	30x30 Tension plate	8.2	30	13	115	100	61802	ΣΚΛΗΡΟ ΑΛΟΥΜΙΝΙΟ	96 gr
<b>TL 40</b>	45x45 Tension plate	10.2	45	13.6	152	129.5	1202	ΣΚΛΗΡΟ ΑΛΟΥΜΙΝΙΟ	207 gr

TIMH/TMX
<b>7,90 €</b>
<b>9,50 €</b>

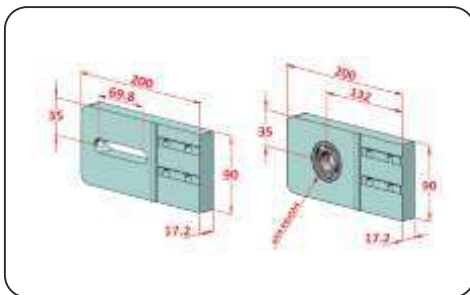
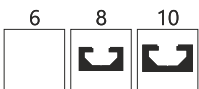

CODE	PRODUCT NAME	A	B	E	L	L1	Roller	Material	Weight
<b>TL 50</b>	30x60-60x60 Tension plate	80	38	20	165	60	-	ΑΛΟΥΜΙΝΙΟ	863 gr
<b>TL 60</b>	30x60-60x60 Drive plate	80	38	20	165	108	6004	ΑΛΟΥΜΙΝΙΟ	931 gr
<b>TL 70</b>	45x90-90x90 Tension plate	90	55	19,3	200	69.8	-	ΑΛΟΥΜΙΝΙΟ	1043 gr
<b>TL 80</b>	45x90-90x90 Drive plate	90	55	19,3	200	132	6004	ΑΛΟΥΜΙΝΙΟ	1115 gr

TIMH/TMX
<b>30,00 €</b>
<b>32,00 €</b>
<b>32,50 €</b>
<b>36,00 €</b>

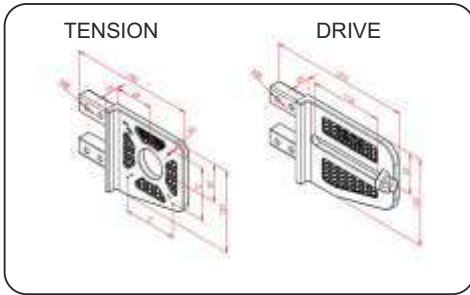

CODE	PRODUCT NAME	Material	Weight	TIMH/SET
<b>TL 100</b>	23x127 Tension Plate	XYTO ΑΛΟΥΜΙΝΙΟ	1162 gr	<b>19,00 €</b>
<b>TL 120</b>	23x127 Drive plate	XYTO ΑΛΟΥΜΙΝΙΟ	972 gr	<b>19,50 €</b>

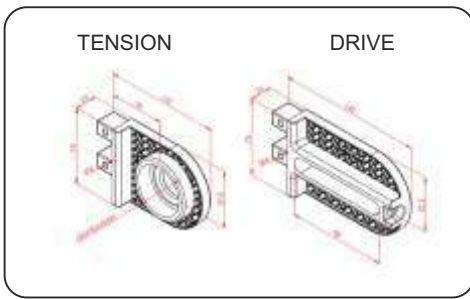

CODE	PRODUCT NAME	Material	Weight	TIMH/TMX
<b>TL 90</b>	23x75 Tension Plate	XYTO ΑΛΟΥΜΙΝΙΟ	181 gr	<b>10,00 €</b>
<b>TL 130</b>	23x75 Drive plate	XYTO ΑΛΟΥΜΙΝΙΟ	256 gr	<b>19,00 €</b>

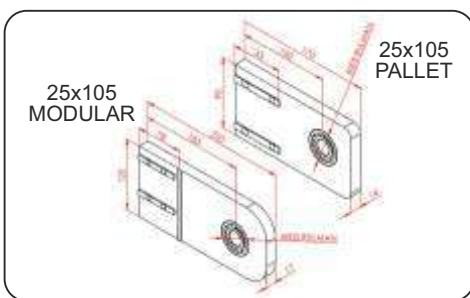

CODE	PRODUCT NAME	A	B	E	L	L1	Roller	Material	Weight	TIMH/TMX
<b>TL 105 M</b>	25x105 Modular conveyor left	90	40	14	170	130	6004	ΑΛΟΥΜΙΝΙΟ	577 gr	<b>24,00 €</b>
<b>TL 105 R</b>	25x105 Pallet conveyor right	90	40	14	170	130	6004	ΑΛΟΥΜΙΝΙΟ	577 gr	<b>24,00 €</b>
<b>TL 105 P</b>	25x105 Pallet conveyor plate	120	65	17	250	185	6005	ΑΛΟΥΜΙΝΙΟ	1343 gr	<b>46,00 €</b>
<b>TL 150 M</b>	25x150 Modular conveyor left	130	65	17	245	165	6005	ΑΛΟΥΜΙΝΙΟ	1400 gr	<b>46,00 €</b>
<b>TL 110 R</b>	25x150 Modular conveyor right	130	65	17	245	165	6005	ΑΛΟΥΜΙΝΙΟ	1400 gr	<b>46,00 €</b>

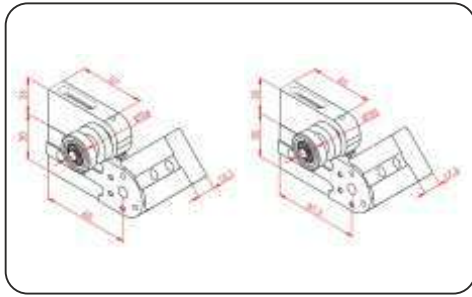
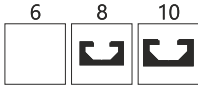

CODE	PRODUCT NAME	A	A1	B	B1	C	D	H	Material	Weight	TIMH/TMX
<b>TL 1</b>	30x30 Miniature conveyor joint plate	30	-	65	-	48	-	13	ΑΛΟΥΜΙΝΙΟ	129 gr	<b>40,00 €</b>
<b>TL 2</b>	30x30 Roller pin & connection parts	-	35,5	-	65	-	33	17	ΑΛΟΥΜΙΝΙΟ	105,5 gr	<b>11,00 €</b>
<b>TL 3</b>	45x45 Miniature conveyor joint plate	45	-	87,5	-	65,5	-	17,5	ΑΛΟΥΜΙΝΙΟ	343 gr	<b>53,00 €</b>
<b>TL 4</b>	45x45 Roller pin & connection parts	-	36	-	57	-	26	14,6	ΑΛΟΥΜΙΝΙΟ	186,5 gr	<b>27,00 €</b>

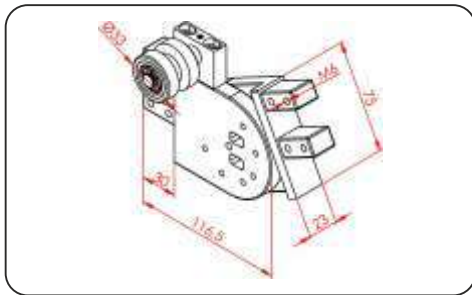

CODE	PRODUCT NAME	A	B	C	Material	Weight	TIMH/TMX
<b>TL 2375 LR</b>	23x75 Conveyor joint plate & roller	48	185	127	ΑΛΟΥΜΙΝΙΟ	450 gr	<b>60,00 €</b>
<b>TL 237550</b>	23x127 Roller $\Phi$ 50 pin & connection parts	29	36	50	ΑΛΟΥΜΙΝΙΟ	100 gr	<b>26,00 €</b>

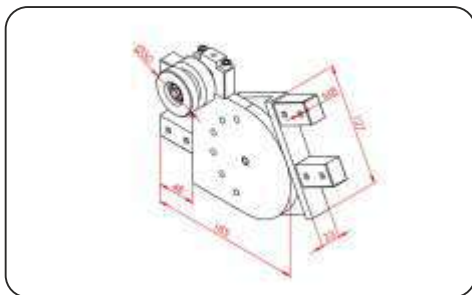

CODE	PRODUCT NAME	A	B	C	Material	Weight	TIMH/TMX
<b>TL 5 R</b>	23x127 Conveyor joint plate right	48	185	127	ΑΛΟΥΜΙΝΙΟ	1289 gr	<b>63,00 €</b>
<b>TL 5 L</b>	23x127 Conveyor joint plate left	48	185	127	ΑΛΟΥΜΙΝΙΟ	1289 gr	<b>63,00 €</b>
<b>TL 6</b>	23x127 Roller $\Phi$ 50 pin & connection parts	39	60	50	ΑΛΟΥΜΙΝΙΟ	230 gr	<b>19,00 €</b>
<b>TL 8</b>	23x127 Elevator interior roller connection	32	-	50	ΑΛΟΥΜΙΝΙΟ	52 gr	<b>7,00 €</b>

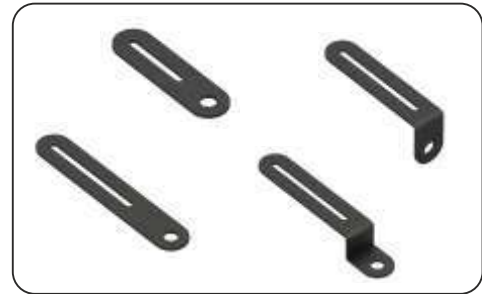
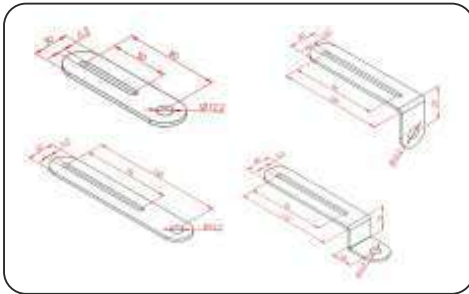
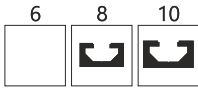

CODE	PRODUCT NAME	A	B	C	D	d	Material	Weight	TIMH/TMX
TL 41	Sensor Connection Cassete Flat	110	30	48,8	12,2	6.2	HRP	61 gr	1,00 €
TL 42	Sensor Connection Cassete Flat	175	30	93,8	12,2	6.2	HRP	106 gr	1,35 €
TL 43	Sensor Connection Cassete Flat (L)	128	30	48	12,2	6.2	HRP	97 gr	1,80 €
TL 44	Sensor Connection Cassete Flat (S)	168	30	28	12,2	6.2	HRP	118 gr	2,30 €
TL 45	Sensor Connection Cassete Flat	110	30	48,8	18,2	6.2	HRP	61,5 gr	1,00 €
TL 46	Sensor Connection Cassete Flat	175	30	93,8	18,2	6.2	HRP	101 gr	1,35 €
TL 47	Sensor Connection Cassete Flat (L)	128	30	58	18,2	6.2	HRP	106 gr	1,60 €
TL 48	Sensor Connection Cassete Flat (S)	186	30	53	18,2	6.2	HRP	146,5 gr	2,50 €

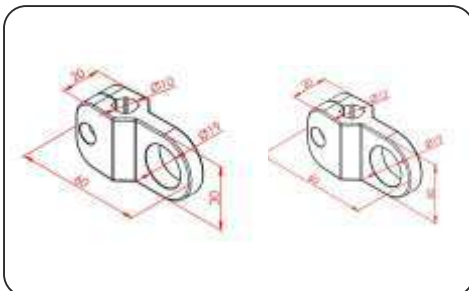

CODE	PRODUCT NAME	A	B	C	D	d	E	Material	Weight	TIMH/TMX
TL 31	Sensor Holder Φ 10	60	20	30	Ø19	Ø10	8	ΠΛΑΣΤΙΚΟ	20 gr	5,70 €
TL 32	Sensor Holder Φ 12	60	20	30	Ø19	Ø12	6	ΠΛΑΣΤΙΚΟ	17 gr	2,50 €

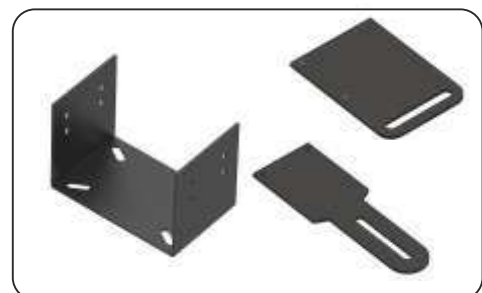
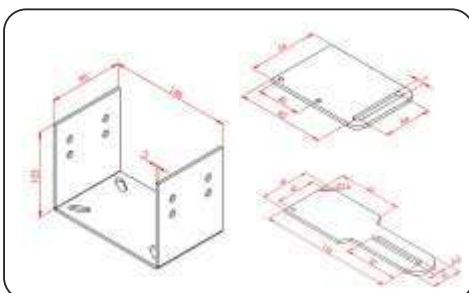

CODE	PRODUCT NAME	A	B	C	D	d	Material	Weight	TIMH/TMX
TL 33	Flat horizontal 3 mm	64	92	44	3,3	7	HRP	126 gr	2,00 €
TL 34	Flat vertical 3 mm	147,5	50	48,8	3,6	6.2	HRP	130,5 gr	2,00 €
TL 35	Conveyor (U) plate	146	90	103	8	8	HRP	685 gr	7,00 €

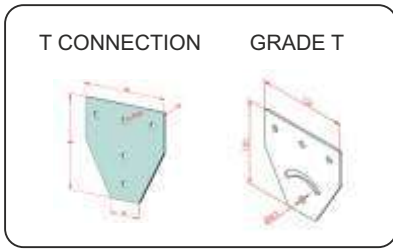

CODE	PRODUCT NAME	A	B	C	D	Material	Weight
TL 51	T Connection	120	126	3	8,5	ZINC	283 gr
TL 52	Grade T Connection	120	126	3	8,5	ZINC	271 gr

TIMH/TMX

2,90 €

3,20 €

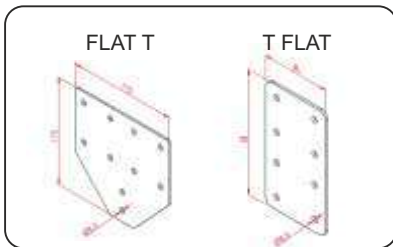

CODE	PRODUCT NAME	A	B	C	D	Material	Weight
TL 53	Flat T Attachment	175	175	3	8,5	ZINC	601 gr
TL 54	T Flat Attachment	180	100	3	8,5	ZINC	563.5 gr

TIMH/TMX

5,50 €

5,20 €

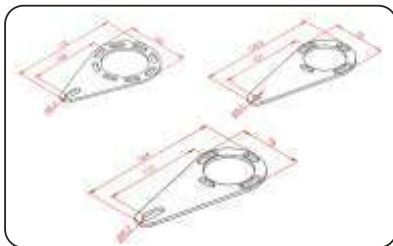

CODE	PRODUCT NAME	D	d	A	B	L	Material	Reducer Type	Weight
TL 55	Torque arm	Ø45	Ø8,2	65	143,5	101	3 mm ZINC	EV 25	95,5 gr
TL 56	Torque arm	Ø55	Ø8,2	78	164	115	3 mm ZINC	EV 30	127,5 gr
TL 57	Torque arm	Ø60	Ø8,5	90	155	100	3 mm ZINC	EV 40	125 gr
TL 58	Torque arm	Ø70	Ø8,5	100	170	106	3 mm ZINC	EV 50	164 gr
TL 59	Torque arm	Ø80	Ø10,5	115	200	130	5 mm ZINC	EV 63	333 gr

TIMH/TMX

2,50 €

3,00 €

3,50 €

4,60 €

6,80 €

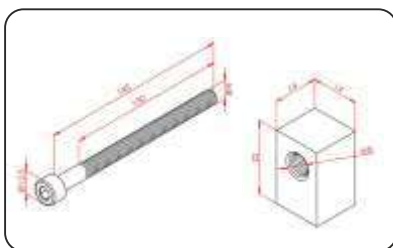

CODE	PRODUCT NAME	Material	Weight
TL 71	23 x 127 Tension bolt	STEEL 8.8	50 gr
TL 72	23 x 127 Tension nut	STAINLESS	29 gr

TIMH/TMX

2,00 €

2,20 €

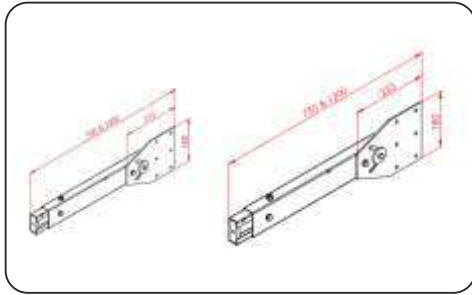

CODE	PRODUCT NAME	A	B	L min	L max	Material	Weight
<b>TL 73</b>	Grade Metal Feet (small)	180	233	570	870	ZINC	3.12 Kg
<b>TL 74</b>	Grade Metal Feet (big)	200	240	750	1200	ZINC	4.82 Kg

TIMH/TMX

**27,00 €**

**43,00 €**



CODE	PRODUCT NAME	Dimension/mm	Inverter	Weight
<b>TL 75</b>	Speed Panel inverter 0,37 Kw	145x150x230	LS-SV-IE5	2.150 gr
<b>TL 76</b>	Speed Panel inverter 0,37 Kw	170x205x300	LS-SV-IC5	2.950 gr
<b>TL 77</b>	Speed Panel inverter 0,75 Kw	170x205x300	LS-SV-IC5	2.950 gr
<b>TL 78</b>	Speed Panel inverter 1,75 Kw	170x205x300	LS-SV-IC5	2.950 gr

TIMH/TMX

**350,00 €**

**380,00 €**

**400,00 €**

**500,00 €**

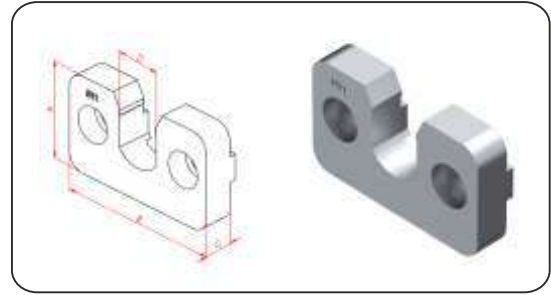
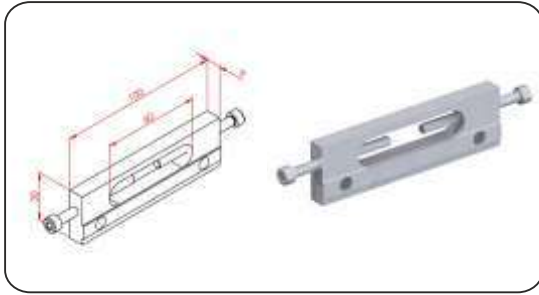

CODE	PRODUCT NAME	A	B	C	ØD	Material	Weight
<b>TL 93</b>	Bottom return roller bearing	100	30	9	7	ΑΛΟΥΜΙΝΙΟ	66 gr
<b>TL 93/50</b>	Roll Bed Ø50	25	50,5	7,5	8	Nylon	10,66 gr
<b>TL 93/51</b>	Roll Bed Ø51	30	51,5	9	14	Nylon	14,55 gr

TIMH/TMX

**8,00 €**

**0,80 €**

**0,90 €**

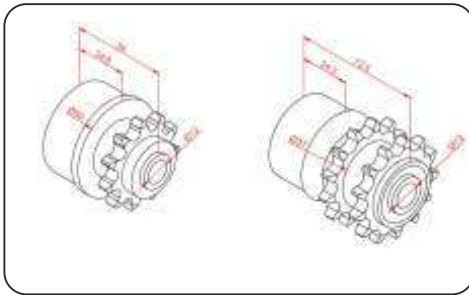

CODE	PRODUCT NAME	A	B	D	d	Material	Weight
<b>TL 94</b>	Roller chain wheel Φ50 1/2	56	24,8	50	12	ΠΛΑΣΤΙΚΟ	82 gr
<b>TL 95</b>	Double roller chain wheel Φ50 1/2	72,5	24,5	47	12	ΠΛΑΣΤΙΚΟ	87,6 gr

TIMH/TMX

**17,00 €**

**18,00 €**

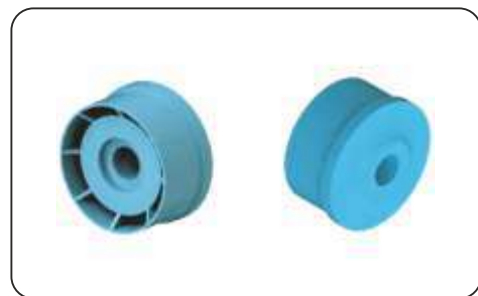
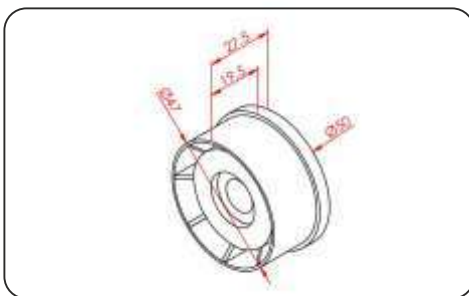

CODE	PRODUCT NAME	A	B	ØD	Ød	Material	Weight
<b>PLS 50</b>	PLS roll head Φ50 x 1,5	27,5	19,5	50	47	ΠΛΑΣΤΙΚΟ	60 gr
<b>PLS 30</b>	PLS roll head Φ30 x 1	27	19	30	28	ΠΛΑΣΤΙΚΟ	11,5 gr
<b>PLS 30 D</b>	PLS roll head Φ30 x 1,5	27	19	30	27	ΠΛΑΣΤΙΚΟ	11 gr
<b>PLS 20</b>	PLS roll head Φ20 x 1	26	18	20	18	ΠΛΑΣΤΙΚΟ	5,5 gr
<b>PLS 40</b>	PLS roll head Φ40 x 1,5	27	19	40	38	ΠΛΑΣΤΙΚΟ	60 gr

TIMH/TMX

**2,50 €**

**1,50 €**

**1,50 €**

**1,40 €**

**1,50 €**





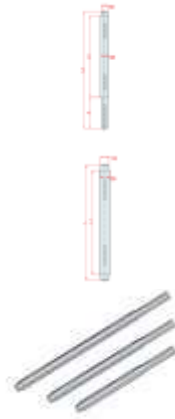
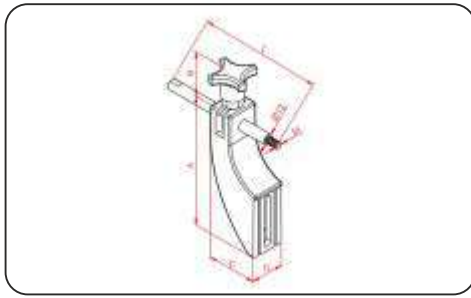
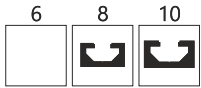

CODE	PRODUCT NAME	ØD	M	L	Material	Weight
TL 131	Console connection kit	-	-	-	Plastic	203 gr
TL 139	Miniature console connection kit	-	-	-	Plastic	179 gr
TL 133	Console connection shaft (120mm)	Ø12	M8	120	Stainless steel	103 gr
TL 134	Console connection shaft (150mm)	Ø12	M8	150	Stainless steel	130 gr
TL 135	Console connection shaft (200mm)	Ø12	M8	200	Stainless steel	175 gr

TIMH/TMX
5,90 €
7,50 €
3,00 €
3,50 €
4,50 €

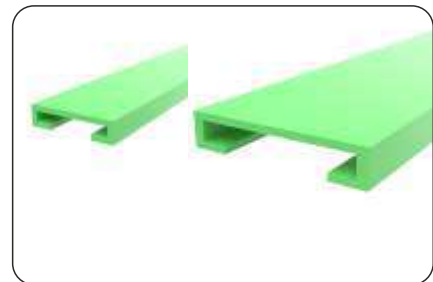
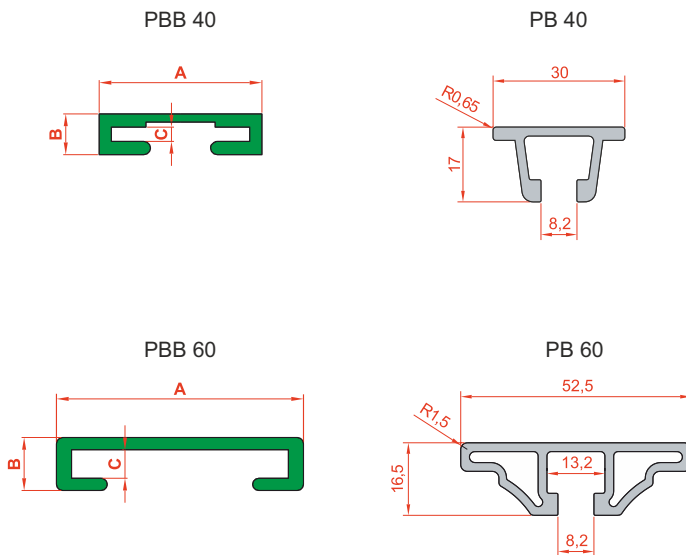

CODE	Size	Quality	L (mm)	Moment of inertia		Area	Mass
				I <sub>x</sub>	I <sub>y</sub>		
PB 40	40 mm	6063	6000	0,50cm <sup>4</sup>	1,06cm <sup>4</sup>	1,52cm <sup>2</sup>	0,41Kg/m
PB 60	60 mm	6063	6000	0,77cm <sup>4</sup>	6,10cm <sup>4</sup>	2,83cm <sup>2</sup>	0,77Kg/m

TIMH/m KOMMATI	TIMH/m 6m ΒΕΡΓΑΣ
6,55 €	5,90 €
11,40 €	10,30 €

CODE	Size	PRODUCT NAME	A	B	C	Material	Mass
PBB 40	40 mm	Side barrier (10x40)	40	9,5	4,5	PVC	0,26 Kg/m
PBB 60	60 mm	Side barrier (13x60)	60	13	7	PVC	0,35 Kg/m

TIMH/m
3,40 €
5,20 €

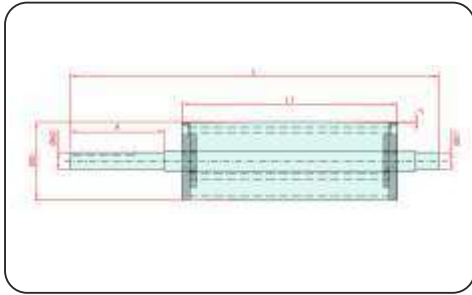

CODE	PRODUCT NAME	ALUMINIUM PROFILE	ΦΑΡΔΟΣ	L	L1	AA	ØD	Ød1	Ød2	Material	Weight
TL 151	Φ76 Tension drum	23 x 127	300	366	315	14	76	20	9	ΑΛΟΥΜΙΝΙΟ	2.557 gr
TL 152	Φ76 Tension drum	23 x 127	450	516	465	14	76	20	9	ΑΛΟΥΜΙΝΙΟ	3.607 gr
TL 153	Φ76 Tension drum	23 x 127	600	666	615	14	76	20	9	ΑΛΟΥΜΙΝΙΟ	4.646 gr
TL 154	Φ76 Tension drum	23 x 127	800	866	815	14	76	20	9	ΑΛΟΥΜΙΝΙΟ	6.321 gr
TL 155	Φ76 Tension drum	23 x 127	1000	1066	1015	14	76	20	9	ΑΛΟΥΜΙΝΙΟ	7.432 gr
TLT 30	Φ76 Tension drum	23 x 75	300	366	315	14	76	20	8.5	ΑΛΟΥΜΙΝΙΟ	2.405 gr
TLT 45	Φ76 Tension drum	23 x 75	450	516	465	14	76	20	8.5	ΑΛΟΥΜΙΝΙΟ	3.457 gr
TLT 60	Φ76 Tension drum	23 x 75	600	666	615	14	76	20	8.5	ΑΛΟΥΜΙΝΙΟ	4.509 gr
TLT 80	Φ76 Tension drum	23 x 75	800	866	815	14	76	20	8.5	ΑΛΟΥΜΙΝΙΟ	5.911 gr
TLT 100	Φ76 Tension drum	23 x 75	1000	1066	1015	14	76	20	8.5	ΑΛΟΥΜΙΝΙΟ	7.314 gr

TIMH/TMX
60,00 €
75,00 €
83,00 €
95,00 €
105,00 €
60,00 €
78,00 €
83,00 €
95,00 €
105,00 €

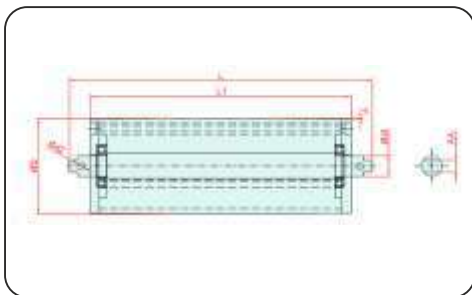

CODE	PRODUCT NAME	ALUMINIUM PROFILE	ΦΑΡΔΟΣ	L	L1	A	ØD	Ød1	Ød2	Material	Weight
TL 156	Φ76 Drive drums	23 x 127	300	516.6	315	82	76	20	18	ΑΛΟΥΜΙΝΙΟ	2.943 gr
TL 157	Φ76 Drive drums	23 x 127	450	666.6	465	82	76	20	18	ΑΛΟΥΜΙΝΙΟ	3.973 gr
TL 158	Φ76 Drive drums	23 x 127	600	816.6	615	82	76	20	18	ΑΛΟΥΜΙΝΙΟ	5.017 gr
TL 159	Φ76 Drive drums	23 x 127	800	1016.6	815	82	76	20	18	ΑΛΟΥΜΙΝΙΟ	6.385 gr
TL 160	Φ76 Drive drums	23 x 127	1000	1216.6	1015	82	76	20	18	ΑΛΟΥΜΙΝΙΟ	7.810 gr
TLD 30	Φ76 Drive drums	23 x 75	300	464.1	315	82	76	20	18	ΑΛΟΥΜΙΝΙΟ	2.745 gr
TLD 45	Φ76 Drive drums	23 x 75	450	614.1	465	82	76	20	18	ΑΛΟΥΜΙΝΙΟ	3.797 gr
TLD 60	Φ76 Drive drums	23 x 75	600	764.1	615	82	76	20	18	ΑΛΟΥΜΙΝΙΟ	4.849 gr
TLD 80	Φ76 Drive drums	23 x 75	800	964.1	815	82	76	20	18	ΑΛΟΥΜΙΝΙΟ	6.252 gr
TLD 100	Φ76 Drive drums	23 x 75	1000	1164.1	1015	82	76	20	18	ΑΛΟΥΜΙΝΙΟ	7.654 gr

TIMH/TMX
65,00 €
74,00 €
83,00 €
125,00 €
130,00 €
65,00 €
74,00 €
83,00 €
115,00 €
130,00 €

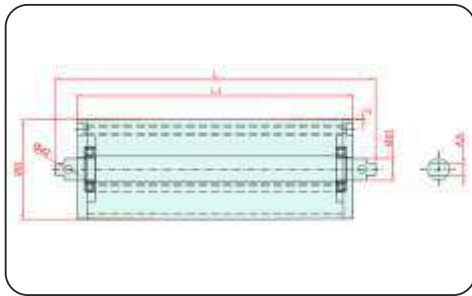

CODE	PRODUCT NAME	ΦΑΡΔΟΣ	L	L1	AA	ØD	Ød1	Ød2	Material	Weight
<b>TD 30</b>	Φ114 Tension drums	300	366	315	14	114	25	9	ΑΛΟΥΜΙΝΙΟ	4.446 gr
<b>TD 45</b>	Φ114 Tension drums	450	516	465	14	114	25	9	ΑΛΟΥΜΙΝΙΟ	6.231 gr
<b>TD 60</b>	Φ114 Tension drums	600	666	615	14	114	25	9	ΑΛΟΥΜΙΝΙΟ	7.665 gr
<b>TD 80</b>	Φ114 Tension drums	800	866	815	14	114	25	9	ΑΛΟΥΜΙΝΙΟ	10.220 gr
<b>TD 100</b>	Φ114 Tension drums	1000	1066	1015	14	114	25	9	ΑΛΟΥΜΙΝΙΟ	12.540 gr
<b>TD 120</b>	Φ114 Tension drums	1200	1271	1220	20	114	30	9	ΑΛΟΥΜΙΝΙΟ	17.160 gr

ΤΙΜΗ/TMX

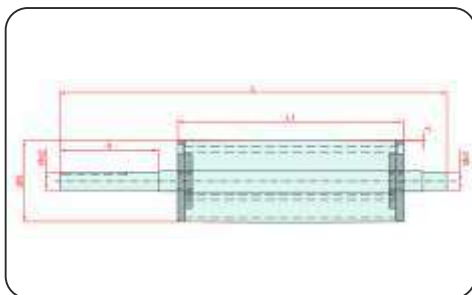
**85,00 €****100,00 €****120,00 €****145,00 €****175,00 €****280,00 €**

CODE	PRODUCT NAME	ΦΑΡΔΟΣ	L	L1	A	ØD	Ød1	Ød2	Material	Weight
<b>TD 30 A</b>	Φ114 Drive drums	300	541	315	138	114	25	25	ΑΛΟΥΜΙΝΙΟ	5.235 gr
<b>TD 65 A</b>	Φ114 Drive drums	450	691	465	138	114	25	25	ΑΛΟΥΜΙΝΙΟ	6.979 gr
<b>TD 60 A</b>	Φ114 Drive drums	600	841	615	138	114	25	25	ΑΛΟΥΜΙΝΙΟ	8.658 gr
<b>TD 80 A</b>	Φ114 Drive drums	800	1041	815	138	114	25	25	ΑΛΟΥΜΙΝΙΟ	10.980 gr
<b>TD 100 A</b>	Φ114 Drive drums	1000	1241	1015	138	114	25	25	ΑΛΟΥΜΙΝΙΟ	13.280 gr
<b>TD 120 A</b>	Φ114 Drive drums	1200	1500	1220	138	114	30	25	ΑΛΟΥΜΙΝΙΟ	18.200 gr

ΤΙΜΗ/m  
ΚΟΜΜΑΤΙ**90,00 €****105,00 €****130,00 €****160,00 €****190,00 €****300,00 €**

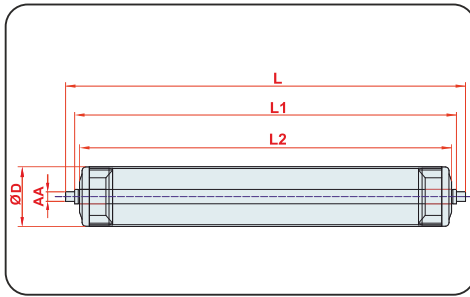

CAPACITY  
250 KG



CODE	PRODUCT NAME	L	L1	L2	ØD	AA	Material	Weight
<b>TL 290</b>	Φ50 x 290 Aluminium roller	335	310	320	50	8	ΑΛΟΥΜΙΝΙΟ	584 gr
<b>TL 440</b>	Φ50 x 440 Aluminium roller	485	460	470	50	8	ΑΛΟΥΜΙΝΙΟ	816 gr
<b>TL 590</b>	Φ50 x 590 Aluminium roller	635	610	620	50	8	ΑΛΟΥΜΙΝΙΟ	1.079 gr
<b>TL 790</b>	Φ50 x 790 Aluminium roller	835	810	820	50	8	ΑΛΟΥΜΙΝΙΟ	1.384 gr

TIMH/TMX

**13,50 €**

**16,00 €**

**18,00 €**

**22,00 €**

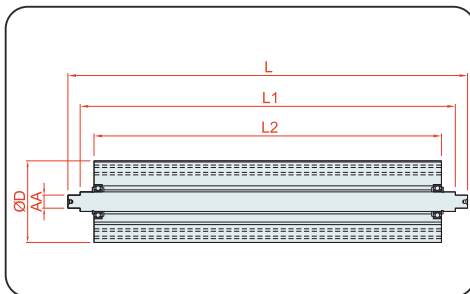

CAPACITY  
300 KG



CODE	PRODUCT NAME	L	L1	L2	ØD	AA	Material	Weight
<b>KNU 29</b>	Φ50 x 290 Aluminium KNURLED	335	310	320	50	8	ΑΛΟΥΜΙΝΙΟ	880 gr
<b>KNU 44</b>	Φ50 x 440 Aluminium KNURLED	485	460	470	50	8	ΑΛΟΥΜΙΝΙΟ	1300 gr
<b>KNU 59</b>	Φ50 x 590 Aluminium KNURLED	635	610	620	50	8	ΑΛΟΥΜΙΝΙΟ	1720 gr
<b>KNU 79</b>	Φ50 x 790 Aluminium KNURLED	835	810	820	50	8	ΑΛΟΥΜΙΝΙΟ	2280 gr
<b>KNU 99</b>	Φ50 x 990 Aluminium KNURLED	1035	1010	1020	50	8	ΑΛΟΥΜΙΝΙΟ	2850 gr

TIMH/TMX

**20,00 €**

**24,00 €**

**28,00 €**

**35,00 €**

**42,00 €**

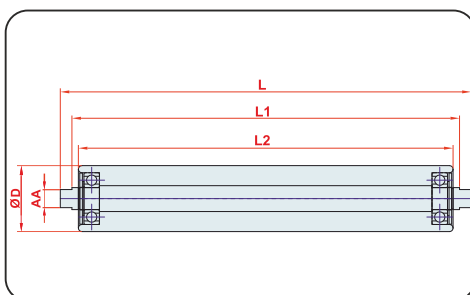

CAPACITY  
400 KG



CODE	PRODUCT NAME	L	L1	L2	ØD	AA	Material	Weight
<b>TL 290 S</b>	Φ51 x 290 Steel roller	318	300	290	Ø51	14	Steel	1603 gr
<b>TL 440 S</b>	Φ51 x 440 Steel roller	468	450	440	Ø51	14	Steel	2426 gr
<b>TL 590 S</b>	Φ51 x 590 Steel roller	618	600	590	Ø51	14	Steel	3162 gr
<b>TL 790 S</b>	Φ51 x 790 Steel roller	818	800	790	Ø51	14	Steel	3987 gr
<b>TL 1000 S</b>	Φ51 x 1000 Steel roller	1018	1000	990	Ø51	14	Steel	4812gr

TIMH/m  
KOMMATI

**22,00 €**

**25,00 €**

**29,00 €**

**35,00 €**

**42,00 €**

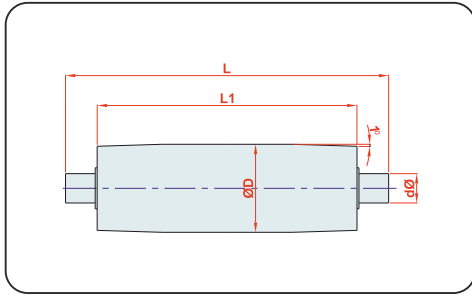

CODE	PRODUCT NAME	ΦΑΡΔΟΣ	L	L1	ØD	Ød	Material	Weight
<b>TDS 25</b>	Φ30 Tension drums	25	42	28	30	15	Steel	160 gr
<b>TDS 55</b>	Φ30 Tension drums	55	72	58	30	15	Steel	346 gr
<b>TDS 85</b>	Φ30 Tension drums	85	102	88	30	15	Steel	645 gr
<b>TDS120</b>	Φ30 Tension drums	120	140	126	34	15	Steel	855 gr

TIMH/TMX

**11,30 €**

**13,60 €**

**14,70 €**

**18,00 €**

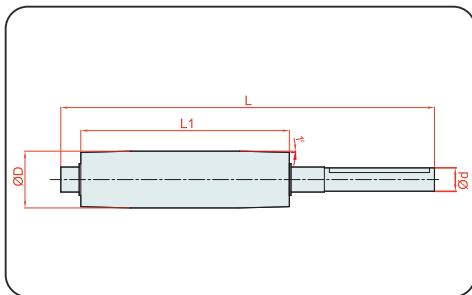

CODE	PRODUCT NAME	ΦΑΡΔΟΣ	L	L1	ØD	Ød	Material	Weight
<b>DDS 25</b>	Φ30 Drive drums	25	121	28	30	14	Steel	256 gr
<b>DDS 55</b>	Φ30 Drive drums	55	151	58	30	14	Steel	455 gr
<b>DDS 85</b>	Φ30 Drive drums	85	181	88	30	14	Steel	723 gr
<b>DDS 120</b>	Φ30 Drive drums	120	219	126	34	14	Steel	989 gr

TIMH/TMX

**20,00 €**

**21,50 €**

**23,00 €**

**25,00 €**

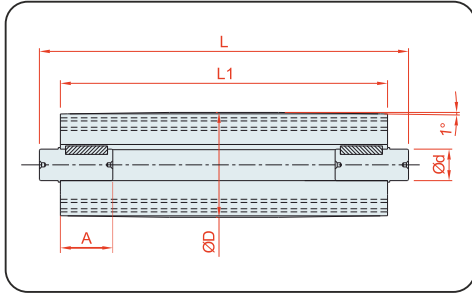

CODE	PRODUCT NAME	ΦΑΡΔΟΣ	A	L	L1	ØD	Ød	Material	Weight	TIMH/TMX
<b>KNT 40</b>	Φ45 Tension drums	40	25	63	43	50	15	ΑΛΟΥΜΙΝΙΟ	170 gr	<b>13,00 €</b>
<b>KNT 85</b>	Φ45 Tension drums	85	25	108	88	50	15	ΑΛΟΥΜΙΝΙΟ	260 gr	<b>19,00 €</b>
<b>KNT 130</b>	Φ45 Tension drums	130	25	153	133	50	15	ΑΛΟΥΜΙΝΙΟ	350 gr	<b>20,00 €</b>
<b>KNT 150</b>	Φ45 Tension drums	150	25	176	156	50	15	ΑΛΟΥΜΙΝΙΟ	390 gr	<b>21,00 €</b>
<b>KNT 175</b>	Φ45 Tension drums	175	25	198	178	50	15	ΑΛΟΥΜΙΝΙΟ	430 gr	<b>22,00 €</b>
<b>KNT 200</b>	Φ45 Tension drums	200	25	226	206	50	15	ΑΛΟΥΜΙΝΙΟ	490 gr	<b>25,00 €</b>
<b>KNT 300</b>	Φ45 Tension drums	300	25	326	306	50	15	ΑΛΟΥΜΙΝΙΟ	607 gr	<b>30,00 €</b>
<b>KNT 450</b>	Φ45 Tension drums	450	25	476	456	50	15	ΑΛΟΥΜΙΝΙΟ	950 gr	<b>40,00 €</b>

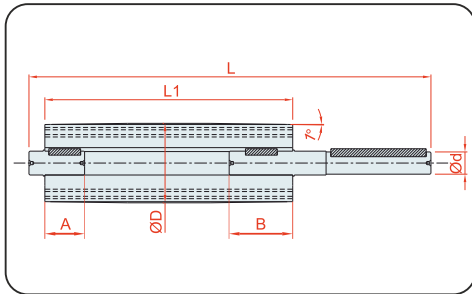

CODE	PRODUCT NAME	ΦΑΡΔΟΣ	A	B	L	L1	ØD	Ød	Material	Weight	TIMH/TMX
<b>KND 40</b>	Φ45 Drive drums	40	25	45	140	43	50	14	ΑΛΟΥΜΙΝΙΟ	270 gr	<b>16,00 €</b>
<b>KND 85</b>	Φ45 Drive drums	85	25	45	185	88	50	14	ΑΛΟΥΜΙΝΙΟ	380 gr	<b>23,00 €</b>
<b>KND 130</b>	Φ45 Drive drums	130	25	45	230	133	50	14	ΑΛΟΥΜΙΝΙΟ	470 gr	<b>24,00 €</b>
<b>KND 150</b>	Φ45 Drive drums	150	25	45	253	156	50	14	ΑΛΟΥΜΙΝΙΟ	510 gr	<b>27,50 €</b>
<b>KND 175</b>	Φ45 Drive drums	175	25	45	275	178	50	14	ΑΛΟΥΜΙΝΙΟ	550 gr	<b>28,50 €</b>
<b>KND 300</b>	Φ45 Drive drums	300	25	45	403	306	50	14	ΑΛΟΥΜΙΝΙΟ	790 gr	<b>37,00 €</b>
<b>KND 450</b>	Φ45 Drive drums	450	25	45	553	456	50	14	ΑΛΟΥΜΙΝΙΟ	1070 gr	<b>42,00 €</b>

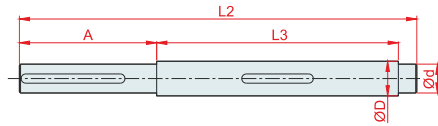
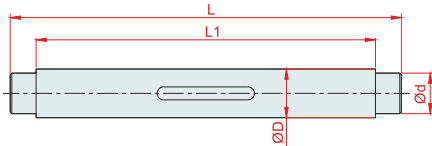

CODE	PRODUCT NAME	ΦΑΡΔΟΣ	L	L1	A	ØD	Ød	Material	Weight
<b>PDM 190</b>	Acetal conveyor tension miller	190,5	241,5	209,5	-	Ø30	Ø25	Steel	1270 gr
<b>PTM 190</b>	Acetal conveyor drive miller	190	344,5	209,5	119	Ø30	Ø25	Steel	1650 gr

TIMH/TMX

15,00 €

24,00 €

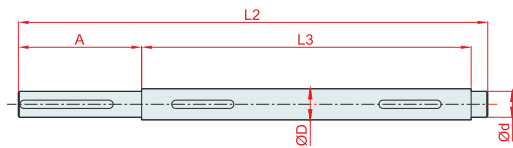
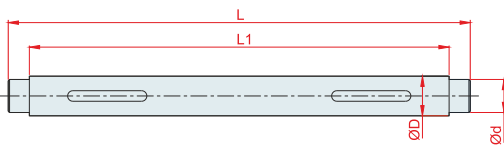
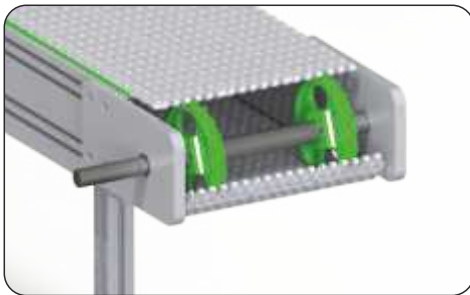

CODE	PRODUCT NAME	ΦΑΡΔΟΣ	L	L1	A	ØD	Ød	Material	Weight
<b>PDM 200</b>	Modular conveyor tension shaft	200	250	218	-	Ø30	Ø25	Steel	1300 gr
<b>PDM 300</b>	Modular conveyor tension shaft	300	350	318	-	Ø30	Ø25	Steel	1860 gr
<b>PDM 400</b>	Modular conveyor tension shaft	400	450	418	-	Ø30	Ø25	Steel	2410 gr
<b>PDM 200 S</b>	Modular conveyor drive shaft	200	353	218	119	Ø30	Ø25	Steel	1680 gr
<b>PDM 300 S</b>	Modular conveyor drive shaft	300	453	318	119	Ø30	Ø25	Steel	2240 gr
<b>PDM 400 S</b>	Modular conveyor drive shaft	400	553	418	119	Ø30	Ø25	Steel	2790 gr

TIMH/TMX

14,00 €

20,00 €

21,00 €

23,00 €

30,00 €

40,00 €

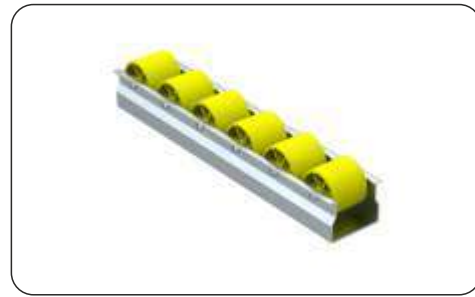
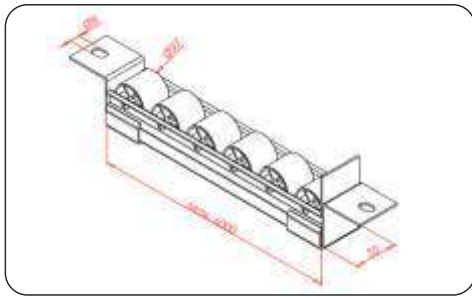

CODE	PRODUCT NAME	Material	Weight
RR 35	Roller Rail	Zinc	959 gr/m

TIMH/m\*  
**13,50 €**

ΔΙΑΤΙΘΕΤΑΙ ΣΕ 6m / 3m ΒΕΡΓΑ

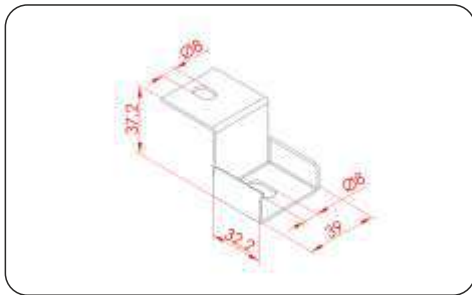

CODE	PRODUCT NAME	Material	Weight
RC 35	Roller R Conection sheet	Zinc	50,5 gr

TIMH/TMX  
**2,85 €**

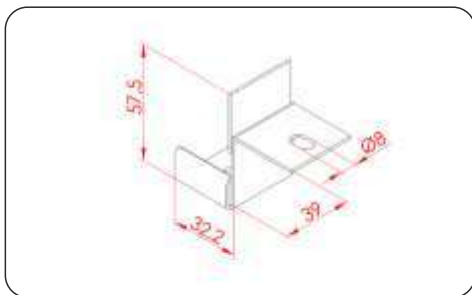

CODE	PRODUCT NAME	Material	Weight
RFS 35	Roller R Fastening & Stopping Sgeet	Zinc	63 gr

TIMH/TMX  
**3,10 €**

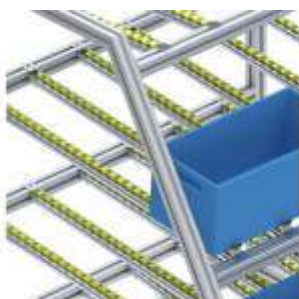





MEIMARIDIS  
BROS



**TOOLS**  
**LAND**

- Στις παραπάνω τιμές δεν περιλαμβάνεται ο Φ.Π.Α.
- Τρόπος πληρωμής μετρητοίς
- Τα μεταφορικά επιβαρύνουν τον πελάτη
- Ο παρών τιμοκατάλογος καταργεί τον προηγούμενο
- Στα προφίλ δεν γίνονται επιστροφές
- Στα εξαρτήματα οι επιστροφές θα γίνονται κατόπιν συνεννόησης
- Χρόνος παράδοσης κατόπιν συνεννόησης
- Η εταιρία δεν φέρει καμία ευθύνη για τυχόν φθορές από την μεταφορά

### **ΑΡΙΘΜΟΣ ΛΟΓΑΡΙΑΣΜΟΥ ΤΡΑΠΕΖΑ ΠΕΙΡΑΙΩΣ:**

Αρ. λογ.: 5242 0035 75529

IBAN: GR 22017 22420 00524 20035 75529



# INDUSTRIAL ALUMINIUM PROFILE SYSTEMS



Systems



Chassis



Conveyors



Machine



ΕΜΠΟΡΙΑ ΣΙΔΗΡΟΥ - ΑΛΟΥΜΙΝΙΟΥ - ΓΥΨΟΣΑΝΙΔΑΣ - ΧΡΩΜΑΤΩΝ  
ΣΟΒΑΔΩΝ - ΙΝΟΧ ΠΑΝΤΟΣ ΤΥΠΟΥ - ΒΙΟΜΗΧΑΝΙΚΑ ΕΡΓΑΛΕΙΑ  
(ΣΤΡΑΝΤΖΑ - ΨΑΛΙΔΙ - ΚΥΛΙΝΔΡΟΣ - ΠΑΝΤΟΓΡΑΦΟΣ)

## ΑΦΟΙ ΜΕΪΜΑΡΙΔΗ Ο.Ε.

Σταδίου 97 - Βέροια

Τηλ.: 23310 23342 - 23178 / Fax: 23310 67869

[www.meimaridis.gr](http://www.meimaridis.gr) | [info@meimaridis.gr](mailto:info@meimaridis.gr)



### MODULAR CONSTRUCTION TECHNOLOGIES

### ΤΙΜΟΚΑΤΑΛΟΓΟΣ

### PRICE LIST

### 2025

### JANUARY

e-mail: [sales@aluminium-profile.gr](mailto:sales@aluminium-profile.gr)

[www.aluminium-profile.gr](http://www.aluminium-profile.gr)

